

Learning Physics in a Virtual Environment: Is There Any?



Gerald W. Meisner¹, Harol Hoffman², Mike Turner³

¹UNC Greensboro.

²Science Lab Courseware.

³Providence Day School, Charlotte, NC, USA.

E-mail: gerald.meisner@gmail.com

(Received 4 April 2008; accepted 5 May 2008)

Abstract

With nearly one in five college students taking at least one course online, with nearly every major college and university offering courses and/or programs online and with a growing number of citizens in the work place wanting and needing education in ways which fit their work and personal schedules, e-learning is becoming more important and ubiquitous each year. The supply (courses) is there in many disciplines; the demand (students and non-students) is there. The unanswered question is: How good is the product? Is learning taking place? How do we measure the learning effectiveness of online courses? Are some courses more amenable than others to e-learning? In particular, is it possible to effectively teach pedagogically sound science courses online? There is little research on many of these questions. Of interest to legislators is another important question: Is online learning cost effective? There is a paucity of data here as well, although some argue that it is possible to have e-learning which is cost effective at the margin [1, 38] provided that an instructional design model is used wherein there is no one 'at the end of the phone' – a model very different from that currently used in the online community. We have collected data from student use of a highly interactive, virtual physics laboratory that answers some of these questions. Data are from an introductory, algebra-based introductory physics course taken mostly by pre-professionals in health fields during the 2005-2006 academic year. Pre- and post- FCI tests were administered in the fall semester when students studied mechanics. Results show that a cadre of students taking 'classwork' in a virtual, highly interactive physics laboratory environment have normalized $\langle g \rangle$ gains [4] on the FCI test [12] which is greater than that of a similar cadre of students in a (physical) modified Modeling Workshop [8] laboratory environment and considerably larger than those in a lecture environment [4].

Keywords: Physics Education, Physics simulation, Virtual Physics Laboratory.

Resumen

Con casi uno de cinco estudiantes universitarios tomando al menos un curso en línea, con casi todos los principales institutos y universidades que ofrecen cursos y/o programas en línea y con un número creciente de ciudadanos que desean y necesitan de educación desde su lugar de trabajo de manera que se adapten a su trabajo y horarios personales, el e-learning es cada vez más importante y omnipresente en cada año. El suministro (cursos) está ahí en muchas disciplinas, la demanda (estudiantes y no estudiantes) también está ahí. La pregunta sin respuesta es: ¿Qué tan bueno es el producto? ¿Se está consiguiendo el aprendizaje? ¿Cómo podemos medir la efectividad del aprendizaje de los cursos en línea? ¿Algunos cursos son más susceptibles que otros para el e-learning? En particular, es posible enseñar de manera efectiva pedagógicamente cursos de ciencias en línea? Hay poca investigación sobre muchas de estas cuestiones. Para los legisladores es de interés otra pregunta importante: ¿Es rentable el aprendizaje en línea? también aquí hay una escasez de datos, aunque algunos sostienen que es posible el tener al margen e-learning rentable [38, 39], siempre que exista un diseño instruccional se ha utilizado el modelo en el que no hay nadie "al final del teléfono" - un modelo muy diferente del que actualmente se utiliza en la comunidad en línea. Se han recogido datos del uso de los estudiantes de un laboratorio virtual de física, muy interactivo que responde a algunas de estas preguntas. Los datos son de un curso de física introductoria sin cálculo que la mayoría de pre-profesionales en áreas de la salud han tomado durante el año académico 2005-2006. Las pruebas de Pre- y post FCI- se administraron en el semestre de otoño cuando los alumnos estudian mecánica. Los resultados muestran que un grupo de estudiantes realizando el "trabajo de clase" en un laboratorio de física con un entorno grandemente interactivo tienen una ganancia normalizada $\langle g \rangle$ [4] en la prueba FCI [12] que es mayor que la de un grupo similar de estudiantes en un entorno de laboratorio de Taller de Modelado físico modificado [8] y considerablemente mayor que aquellos de un entorno de clases [4].

Palabras clave: Educación en Física, Simulación en Física, Laboratorio virtual de Física.

PACS: 01.40.Fk, 01.50.H-, 01.50.hv, 01.50.Lc, 01.50.Qb

I. INTRODUCTION

Research over the past 30 years [1, 2, 3] has shown that students fail to evidence deep understanding of science content and process when subjected to conventional instruction of lecture and demonstrations. Synergistic research by cognitive and physical scientists in the past several decades have given rise to successful efforts in challenging the solipsistic way in which students are being taught. Physics education research or PER [4, 5] has shown that highly interactive engagement of physics students based on pedagogy that has an element of careful guidance is critical for deep learning of physics. Transmission of information, no matter no skillfully or artfully presented, does little more that convince students that a memorization of facts and equations is the *sine qua non* of science in general and physics in particular. Furthermore, we now know that carefully crafted lectures, including (passive) visuals, whether *in situ* or a virtual space, will not help to answer in the affirmative the question posed by Hake in a recent article [6]: “Distance and Classroom Learning: Is There Any?”. The reason for these failed educational ‘experiments’ may be explained by what educational psychologists call the “curse of knowledge” [7]: ‘The more one knows, the more difficult it is, for most people, to understand how some other person could not know what we know.’ In designing the virtual learning environment, we have avoided this curse by careful use of research into misconceptions which students bring to the table and how students learn [5]. The past 20 years of PER has enabled those in this reform movement to put to rest the notion that good teaching is an ‘art’ possessed by only a select few. Rather, by examining the conclusions of this research, many in the physics community are now using highly interactive pedagogical methods which result in their students showing considerable improvement in basic and conceptual understanding of physics [4]. We have been guided by this approach in authoring our asynchronous virtual physics laboratory environments, LabPhysics. The software is modular and multi-purposed – it can be used as a platform for courses horizontally across the sciences and vertically within a specific discipline; the first course authored with the software is an introductory, college (or high school) level physics course in mechanics.

LabPhysics includes both the process and content of science – essential components for any course for students entering upon a study of the discipline. The scientific process, including detailed and highly interactive laboratory investigations, with decision-making, selection of equipment and instrumentation, data collection and analysis and the capability to make mistakes, are essential components of the experience. The process followed in LabPhysics consists of those procedures followed by bench scientists in their daily investigations in the science laboratory. The principle guiding the implementation of this process and the development of both the software architecture and the story-boarding of tutorials which comprise the LabPhysics Mechanics course is the Modeling Workshop [8] pedagogy, a highly acclaimed and

NSF-funded program. This approach is one of several in the movement to reform the teaching of physics, and leads students to investigate patterns in the physical (or realistically virtual!) world and to map them onto specific conceptual systems using various representations. It uses a variation of Karplus’ learning cycle [9, 10], which for Modeling purposes consists of exploration, model development and formulation, model deployment and finally, synthesis. Transferring conclusions from studies in cognitive psychology [11] into the learning environment enable students to use models as learning aids for both understanding and later retrieval.

Students using the Modeling approach have consistently scored significantly higher [4] on standardized ‘conceptual’ exams (the FCI [12], for example) than have students in traditional (lecture) learning situations. An instrument (Reformed Teaching Observational Protocol or RTOP [13] to quantify the extent to which research-based reforms have been implemented in a setting has recently been developed. The instrument consists of twenty-five questions worth from 0-4 points. Studies [14] show a high correlation between high scores on RTOP and student achievement (concept understanding and reasoning skills). A LabPhysics RTOP score of 81 out of 100 and the result of the study by Lawson [14] correlates well with this investigation that showed an average Hake $\langle g \rangle$ factor score of LabPhysics students nearly twice that of a control group.

In spite of evidence linking reform teaching procedures and student learning, the reform movement in physics teaching has progressed slowly beyond a committed core, for reasons having to do with inertia, lack of awareness, reward structure, physical space, equipment and teaching loads. The growth of online education further complicates the problem. There are more than 3.5 million students taking at least one online course in the United States [15], a number which is growing at a yearly rate of nearly 10 percent, or six times faster than the total number of higher education students. The growth in science courses is smaller but still robust and requires more effort and resources for implementing the highly interactive environments that are requisite for deep learning.

Without interactive online science laboratories, we lack the necessary tools for delivering high quality online science courses, for conducting essential research into human-computer interactions and interactive settings that promote and enhance learning of science concepts and model-building in online settings, and for establishing limitations on virtual training of personnel in disparate settings. Despite the proliferation of online universities, robust continual learning auxiliaries of colleges and universities, ‘open courseware,’ and laboratory simulations, there have been remarkably few sustained and successful collaborative efforts to bring together the interdisciplinary experts in technology, content area, design, and discipline-based education research needed to address the creation of effective virtual laboratories. There are, however, a plethora of approaches with somewhat different teaching objectives. One such approach, MIT’s Open CourseWare or OCW (MIT) [41], consists of video taped lectures, demonstrations, problems and small labs

such as a traditional lecture-based course would have -> all on the web and open to all. OCW is suitable for those students who are adept at abstract learning in the lecture tradition, and want to go beyond the material presented at their school. OCW fills a niche for those seeking the experience of seeing lectures delivered by eminent scientists at MIT. Nonetheless, such an approach has, *a fortiori*, many of the problems addressed by Hake [6] – those learning problems inherent in a format based almost entirely on the delivery of information. Christian and Belloni [16], Kiselev [17] and others have authored single concept Java applets that behave as visual spread sheets, enabling the student to quickly see the effect of changing a variable in optics (e.g., object distance affecting image distance for constant converging lens focal length), mechanics (e.g., mass affecting acceleration for constant force), circuits (changing resistance for constant voltage in simple DC circuit), etc. These times - saving visuals assist students in understanding the affects in given mathematical expressions of a variable change. A more holistic approach has been employed by the University of Colorado at Boulder team [18] wherein students see a cartoon-like laboratory simulation embedded in a discussion of the phenomena to be examined. Flash animations such as these can help students visualize relevant mathematical expressions describing a physical situation. Such activities comprise one phase in the learning cycle espoused by Karplus [1], Hestenes [8] and others, and are thus valuable in the sense that they incorporate part of the cycle. The activities generally either leave a large footprint devoid of research – based pedagogy (entire courses of online lecture notes and power point presentations, both visual and oral) or they leave a small foot print based on a small component of the learning cycle (experimental simulations, applets).

Lacking was a comprehensive online approach, based on results of the physics education research community and using the best of the rapidly evolving technologies. The desired approach to online learning in the sciences, then, has to simulate, as best as possible, the entire student learning experience in a scientific setting – in a virtual science laboratory wherein students could interact with equipment, apparatus, mentor, and peers in ways that closely emulate a physical approach to learning by interactive engagement.

The approach of LabPhysics is to expose the user to all aspects of the learning cycle in her virtual laboratory immersion: engagement, exploration, explanation, elaboration and evaluation. Or, in Modeling Workshop [8] language, engage, explore, develop, deploy, and assess. It is a comprehensive approach and closely emulates best practices in the (physical) laboratory environment. The approach must adhere to the charge by Arons [19] to guide the inquiry and help students gain some insight into the practice of scientists, so that they will not leave their learning experience with little more than what Whitehead [20] described as “inert ideas”. LabPhysics courseware incorporates features unique to the online medium: (virtual) mentor, (virtual) collaborators, transparent computer-human interface and time-critical and meaningful assessment. Some of these general

requirements have recently been enumerated in more detail by Boettcher [21].

In order to answer the question: ‘Can Student Learning Take Place in an Online Environment?’ we must ask four preliminary questions:

- i. What is the discipline?
- ii. How do we measure learning?
- iii. How can we carry out a suitable investigation?
- iv. Do we have a suitable instrument to carry out the investigation?

We limit ourselves to physics, and although we examine other aspects of learning, we will use the FCI test as a measure of learning accepted by many in the physics community. Learning a laboratory science should include meaningful laboratory investigations; we must create a virtual laboratory that simulates a physical one as closely as possible. Lacking haptic capabilities, we permit students to explore other laboratory activities as closely as is technologically possible and compare physical and virtual experiences as meaningfully as possible. Although the canonical double blind study is the gold standard for measuring effectiveness, such a technique is clearly not possible in this situation. Our substitute for that ideal was to have two cadres of students, each taught by the same instructor, with the same exams, homework, assigned text, semester projects and grading system, but with one cadre immersed in a physical lab and the other in a virtual lab. However, there was no existing software/instrument to use for such an investigation. We decided to create one.

II. SOFTWARE

Funded in part by a grant from the U.S. Department of Education (Grant No. P339B990329), we have designed and built (LabPhysics) software which has the requisite characteristics.

- Architecture to enable interactive engagement, [8] based on Modeling Pedagogy that is the *sine qua non* behind the scripting and guided, laboratory-based tutorials. LabPhysics tutorials emphasize the scientific process and learning cycle, thus permitting deep problem-solving analyses after the necessary model-based scaffold has been built and understood by the student. Stored data for each student permits ‘flagging’ of each student’s misconceptions [22, 5] as well as her preconceptions [22] and learning facets [23]. In addition, correlations among misconceptions with the various representations of models can provide insight into student learning [24]. A virtual tutor guides students, as would an expert modeler, in, say, Hestenes’ Modeling Workshop. Traditional ‘end of the chapter’, multiple choice and true-false can be authored and incorporated into the software.
- Procedures to assess student content understanding within the tutorial settings under varying conditions. Students are exposed to both higher-level concepts/tasks in which they deploy their developed models in novel situations, and lower level tasks such as learning how to

use instruments and equipment, or how to identify dependent and independent variables in an experimental investigation. Assessment and evaluation questions are being authored which go beyond the common algorithmic questions at the ‘end of the chapter’. With appropriate courseware tools for faculty and student use, online environments permit a richness in assessment not possible with ‘hard’ media. We have authored a variety of these tools which permit faculty access to instantaneous qualitative grading capabilities hitherto lacking: LabGraph, LabAnalysis, LabVector and LabMotionMap. These instruments have unique features that permit faculty to *qualitatively* (as well as quantitatively) grade a student’s understanding of graphs, vectors, and kinematics. As with all online developments, midcourse corrections can be easily and

quickly executed. The extensibility of the LabPhysics approach, along with authoring tools we are developing, will permit a community of developers to quickly emerge, both here and in other countries. Multiple branching forks (keyed to student responses) currently guide students of various backgrounds and educational experiences through different paths of learning.

- Administrative tools for faculty use to monitor student progress (read and insert comments in student virtual notebooks, examine patterns of online usage, etc.).
- Development tools to permit the creation of different mechanics courses, based on the needs of the end users.

A schematic of the LabPhysics architecture is shown in Figure 1

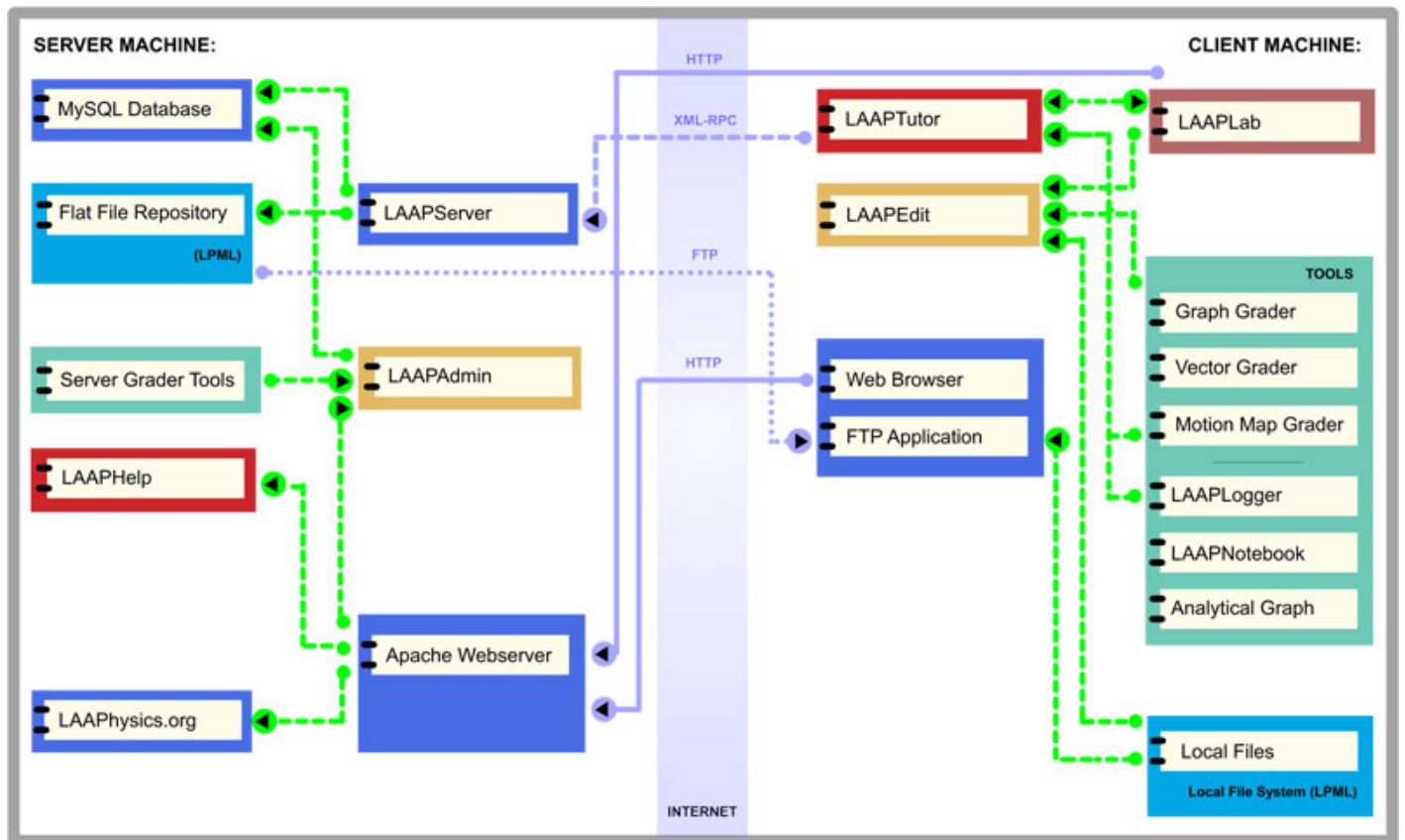

FIGURE 1. LabPhysics Architecture Schematic.

The instrument can be used for a stand-alone online course or employed for both large class laboratory augmentation or substitution where no lab-based course exists, making use of many recent Internet, language and graphics advances.

III. OVERVIEW OF LABPHYSICS

A. Pedagogical Framework

The design and implementation of LabPhysics is governed by close adherence to Modeling Pedagogy [8]. In Modeling pedagogy, complex physics principles are

conceived in terms of a hierarchy of working models. So that students are able to develop a complete working knowledge of, for example, the concept of motion (interactions between matter and force), students begin by understanding the simplest interactions such as constant and relative velocity. They then move on to more complex concepts (statics and circular motion, for example). Since scientific investigations and model building activities are central to the learning milieu that PER has identified as an effective learning environment, it is important when investigating student learning, whether in the real physical laboratory or in the virtual laboratory environment, to include measures that correspond to actual laboratory practice. This requires measuring, under a variety of

conditions, behaviors that typify those of laboratory scientists: 1) the ability to understand and produce different representational models (verbal, graphical, diagrammatic, mathematical) of the relationships among relevant variables; 2) the ability to design and execute experiments with appropriate tools (which demands problem solving competency), and 3) the ability to transfer learning from one experimental context to another (see discussion on capstone investigation below). Student assessment practices that only measure a student's ability to solve 'end of chapter problems' provide little data on these critical STEM competencies, but rather measure a valuable but limited skill - that of applying algorithms to solve specific word problems.

B. Modeling Framework in a Virtual World

LabPhysics has been designed to incorporate, as faithfully as possible, the fundamental components of the Modeling pedagogy classroom setting. The software package includes a series of curriculum tutorials that contain *model development* investigations in which students work in an open-ended online laboratory environment with 'virtual' peers (real peers are, of course, also possible with chat, text messaging or cell phone). A second component of each curriculum module includes a comprehensive *model deployment* activity, the capstone experiment, which is designed to assess student ability to transfer learning from one experimental context to another.

The LabPhysics capstone experiment helps cut the contextual strings between the model constructed by the student during the model development phase, and the specific context or circumstance in which that model was constructed. These activities expand on the development of 'context rich' problems from the University of Minnesota PER group [25] and of the 'experiment problems' from the Ohio State University PER Group [26]. Capstone experiments immerse students in a contextual and media rich virtual environment where they are forced to make decisions on how to proceed (assumptions and variable data are not pre-defined). Students must also make appropriate measurements, often designing an investigation and collecting (their own) data in order to achieve success. These tasks evaluate student understanding in a virtual environment similar to that encountered by scientists in a physical world. Student learning can be evaluated by comparing student predictions to their experimentally measured quantities, or by analyzing representations that students employ and/or events that occur in the virtual experimental environment. Student behavior also can be evaluated on the basis of each student's overall strategy choices and the individual steps they take to reach their solution. Such evaluations go far beyond conventional assessment mechanisms [40] and are not limited by class size.

The Constant Velocity tutorial provides an example of the curriculum pedagogy. In the tutorial, the virtual mentor guides the student through the process of constructing a model of an object moving with constant velocity. The student develops this model through the two stage modeling cycle. In the model development stage, the

student empirically develops the functional relationship between position and time and learns to represent that relationship verbally (written), then diagrammatically (using motion maps), graphically (position versus time and velocity versus time), and finally, mathematically [linear relationships: $x = vt + x_0$; $v(ave) = x / t$]. The emphasis on the use of multiple representations of the model is designed to strengthen the student's conceptual understanding of the model as well as to improve qualitative reasoning ability.

C. LabPhysics Courseware

The LabPhysics courseware permit students to: 1) conduct their own scientific investigations in a guided environment; 2) move through an introductory physics course in either a linear or nonlinear fashion at the discretion of the student or the instructor, depending on the desired learning goals; 3) move asynchronously to accommodate learning styles, differing academic strengths, work, family and health-related time constraints. Student understanding of the principles developed in each tutorial are evaluated by analyzing student responses to questions at various points in the tutorial. 'Checkpoint' questions within each tutorial chapter provide formative assessment, requiring students to immediately apply concepts and skills. The capstone problem appears at the end of each tutorial to provide summative assessment.

Model development in each LabPhysics tutorial begins by presenting the student with a situation ('ponderable') that establishes a need for the model. In the constant velocity tutorial, the student is asked to imagine a scenario in which s/he is a police officer who has to quickly reach an accident scene. The student knows that s/he can travel along a straight road to reach the scene but the police dispatcher needs an estimated time of arrival. This situation establishes the need in a believable setting for determining a functional relationship between position and time at constant velocity. After receiving the information from the dispatcher, the student is invited to experiment (make observations) with the police car apparatus in the virtual lab space. Model development continues through a paradigm lab activity wherein the student interacts with a system that displays all relevant aspects of the model. The student analyzes the motion of the police car moving in a straight line with a constant speed. The student observes the system, identifies and isolates measurable variables associated with the system, then collects and analyzes data to draw conclusions about the functional relationship between these variables.

Students are guided in developing their model via discussions with the virtual guide agent and virtual peers. The developed model is used for explanation, prediction, and further investigations. After the model has been developed, the student deploys it in novel situations. This includes applying the model to other objects moving with constant velocity as well as applying it to multiple objects moving with different constant velocities. These deployment activities serve two functions: 1) to separate the student's understanding of the model from the specific context in which the model was developed, and 2) to let

the student experience the efficacy as well as the limitations of the model. PER has shown that this concrete approach is needed for a deep and lasting understanding of basic principles.

Insights from PER research guided the selection of technologies, the system architecture and computer-human interface issues. Conventional simulations emphasize model deployment (solve a particular problem with recently presented information) and too often are extensions of the lecture and demonstration model, a practice which research has shown to limited success in promoting student learning [27]. Within the LabPhysics virtual environment, students have the freedom to explore and then undertake a series of guided scientific investigations that lead them to construct and ultimately test their own models of physical reality.

D. Courseware Components

The virtual laboratory courseware currently encompasses three main components with which the end-user interacts.

1) A simulated, open-ended laboratory workspace (Figure 2) with virtual laboratory equipment and apparatus objects, the parameters of which can be modified, altered and controlled as well as misused, by the user in an experimental setting (students drag these objects from the equipment cabinet onto the lab table environment in order to set up their own experiments and collect and analyze real-time data generated within the software by standard differential equations);



FIGURE 2. Laboratory environment for constant acceleration investigations.

2) Integrated, interactive exploration-based curriculum tutorials (Figure 3) that "branch" according to student input. Tutorial content includes a collaborative learning

environment in which students work with "virtual peers" and are guided by a virtual tutor [guide agent];

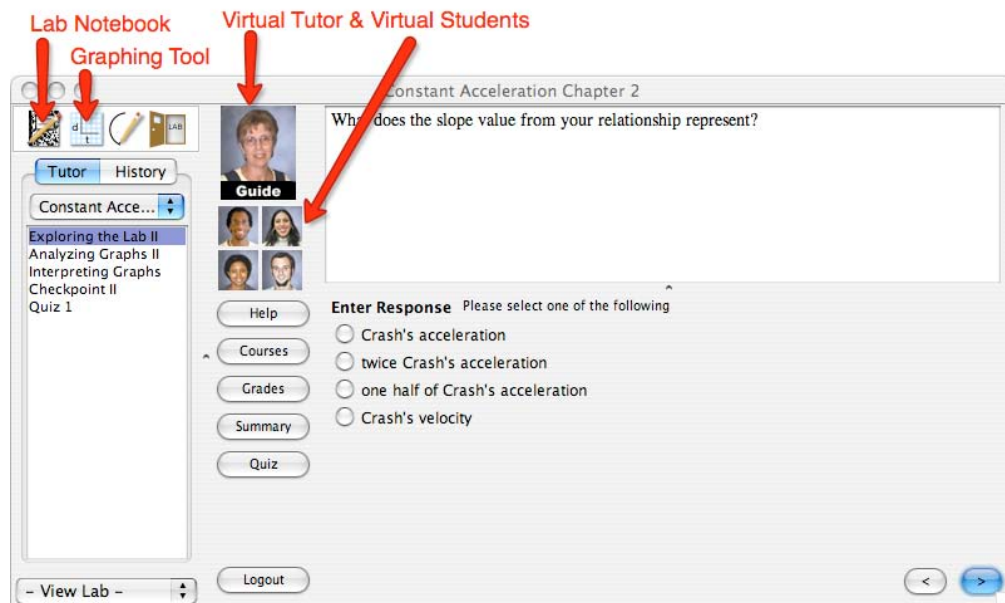

FIGURE 3. Tutor Window. The guide agent assesses student understanding of a previous investigation.

3) Student laboratory tools that include an interactive scientific laboratory notebook and white-boarding tools. All tools are integral parts of the system and communicate with the Tutor and database: The Analytical Graph Tool

(Figure 4) is a basic graphing tool that allows the user to enter data, create and manipulate graphs, and evaluate and analyze graphed data.

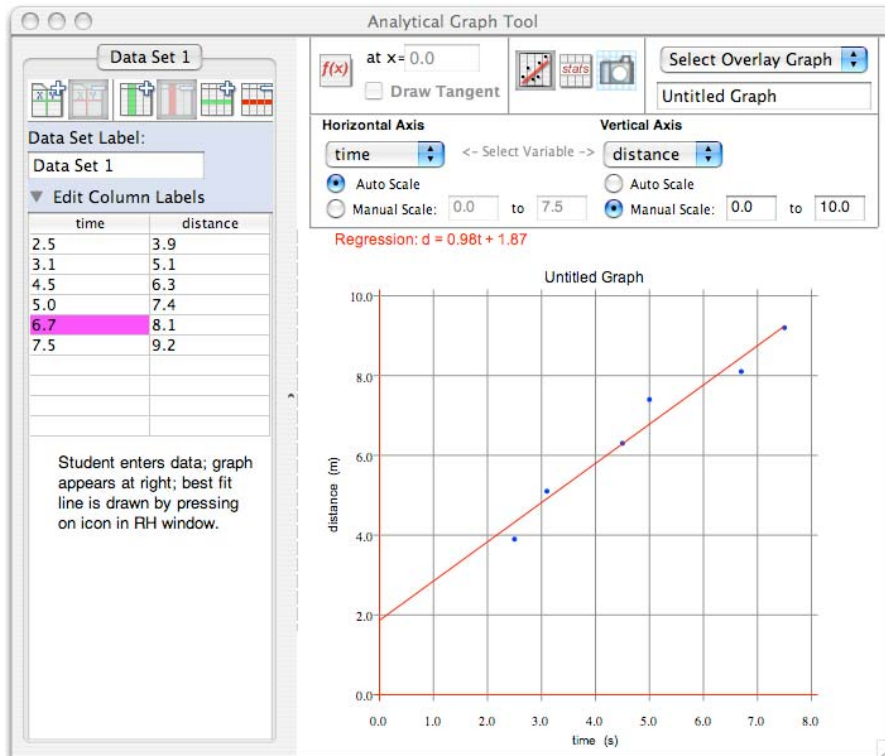

FIGURE 4. Graph Tool for discrete data points

LabLogger is a separate version of the graphing tool that opens automatically when students export their data from the 'mini-logger' inside the virtual lab environment, in a manner similar to that employed by physical data-collection instruments. The graphs displayed in Figures 5 and 6 show data taken by the 'real' student' in her constant acceleration investigation with ramp, stand, cart, launcher,

motion detector, interface and computer in her laboratory. The student saved the data to the LabLogger application by clicking 'keep this graph' in the data logger readout at top left in Figure 5. The Logger tool then opens up, as is shown in Figure 6.



FIGURE 5. Student investigation of constant acceleration using motion detector.

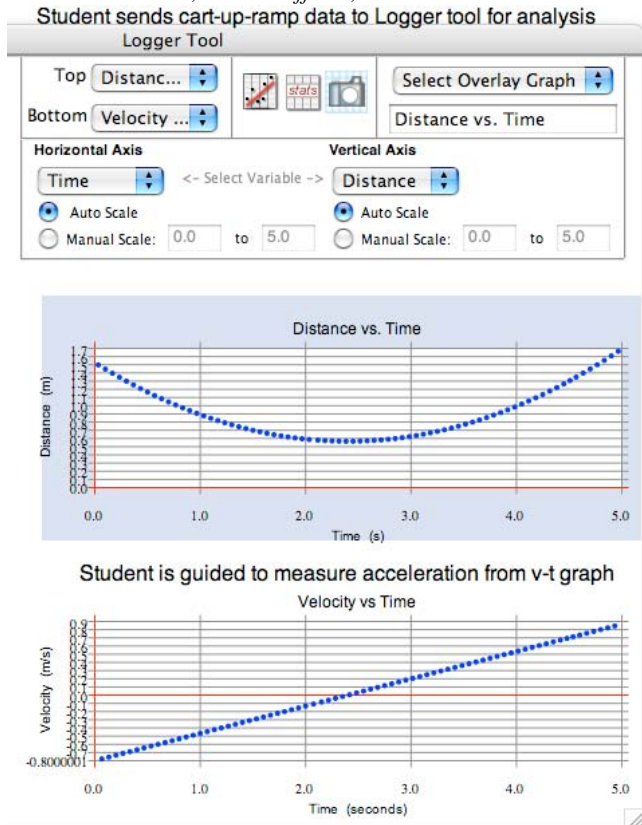

FIGURE 6. Data from investigation shown in Fig. 5 sent to logger tool for analysis.

Each of these tools sends their contents to the database for review by the student or their instructor, and each can be run as an Applet inside a browser.

The LabNotebook tool is a basic word processing application that permits the user to record data and notes, draw and or copy and paste graphs, images, and sketches from either the graph or drawing tools. LabNotebook runs inside the Course Administration tool (LabAdmin) as an applet (in 'teacher mode'), which enables faculty to read student notebooks and insert notes in the margins of the notebook pages. The LabDraw tool is a small drawing tool inside the notebook that provides a 'sketch pad' that students use to work out ideas and quickly sketch diagrams.

The backend server consists of various automated grading and tutorial tools including a qualitative graph grader, vector grader, and motion map grader tool; assessment database and scriptable assessment tools with automated grading functions (t/f; multiple choice; multiple select; ranking; fill-ins); and a communication tool that allows students to organize and present their results so that the real student's results can be compared to the results of the virtual students in simulated 'white-boarding sessions'. The server sends the course content files (a small unit at a time) to the client, receives data back from the student, and sends more course content out to the student based on the data received. The server is designed to keep track of all student actions in the learning environment, including student actions in the laboratory workspace, in order to allow the tutor to respond to the student in an appropriate manner.

IV. PREVIOUS STUDIES WITH LABPHYSICS

With limited statistics, three studies using LabPhysics have yielded results indicating that students who use this learning tool do as well or better and learn as much or more than control groups. While promising, these studies illustrate the need for more data and more definitive comparisons.

A study by Turner [28] measured how the use of the LabPhysics online kinematics tutorials affected student cognition of physics concepts in kinematics. Subjects were college and high school students, most of whom had not taken a high school physics course nor were currently enrolled in a physics course. Subjects were paid an hourly rate of six dollars to participate in the study and were promised an additional \$25 for 'taking their job seriously'. Subjects completed three kinematics tutorials: Underpinnings (Experimental Foundations), Constant Velocity, and Constant Acceleration.

In Turner's study, the normalized gains between pre-instruction and post-instruction scores on the Test of Understanding Graphs in Kinematics (TUG-K) [29] for the treatment group were calculated. These gains were compared to normalized gains typically found for students taking face-to-face physics courses. Normalized gain scores for LabPhysics subjects were found to be statistically equivalent to scores typically found in face-to-face courses.

The study was limited by the fact that the test subjects were not enrolled in a for-credit course. Subjects with limited math background (unlike many students taking physics) were taken 'off the street' and progressed through only three tutorials with no fear factor of grades and yet achieved normalized gains about the same as regular physics students (but not as large as students taking a reformed physics class). We can then posit that learning kinematics using LabPhysics tutorials is: 1) as efficacious as learning occurring in lecture classes, and 2) possibly more efficacious due to the difference in backgrounds of students in regular physics classes and those of the test subjects. However, more research on the efficacy of LabPhysics learning needs to be done, including comparison with: 1) 'off the street' test subjects taking a non-reformed 'lecture-notes-online' physics course, and 2) 'regular' physics students using LabPhysics for credit and grades. In another part of the same study, Turner compared normalized gain scores for LabPhysics student-subjects with 'time-on-task' variables as measured by connectivity to the online software (such information is stored on the server for each student). This analysis revealed a positive correlation with connectivity time and student understanding of kinematics concepts, regardless of the background of the student subjects. This led the author to conclude that the interactive tutorials: 1) are a valuable tool for analyzing change in conceptual understanding over time; 2) can reveal specific difficulties that students have with kinematics concepts; and 3) can lead to observable changes in student understanding.

Mzoughi [30] compared two groups of physics students, one taking a traditional in-class 'orientation lab' at the start of the academic year and the other taking the

LabPhysics Underpinnings tutorial. Both the ‘orientation lab’ and the Underpinnings tutorial covered the same topics (experimental design, dependent/independent variables, graphing, etc.), and used the same experimental task - an investigation of a swinging pendulum.

Mzoughi evaluated the two groups at the end of the session and found no statistical performance differences between them. These studies seem to indicate that there is now the cost-saving option of using LabPhysics as a learning tool – an option that could permit scarce human and monetary resources to be used elsewhere in the physics curriculum.

V. CURRENT STUDY:

A. Student Background

In the fall semester, 2005, 63 students registered to take the first semester (mechanics) of an algebra-based, introductory physics class taught by one of the authors (GWM). The course, mainly for pre-professionals in the health fields, consists of three, two-hour laboratory sessions, using a modeling workshop pedagogy. Physical space restrictions limited the number of students in the (physical) lab to 40. The students were selected based on the date they registered for the course. The other 23 students were given four options: (1) take the course in lecture format from another instructor, (2) wait and take

Learning Physics in a Virtual Environment: Is There Any?

the author’s course the following year, (3) take a similar course in lecture format at another college in the city, or (4) take the same course as the other 40 students, with the exception that all ‘class time’ would be spent in a virtual physics lab environment – using LabPhysics. Twenty-two of the 23 students elected option (4). Course requirements for these students, including homework, weekly quizzes, tests (including physical lab investigations), and semester projects were the same for this ‘mixed mode’ group of 22 students as they were for the ‘physical lab-class’ group of 40. Tests were administered on the same day and at the same time, schedules permitting, *in situ*. The physical lab-class group had 24/7 access to the lab room and the ‘mixed mode’ group had 24/7 internet access to the virtual lab. Both groups had similar out of class access to the instructor. All physical lab students worked in collaborative groups, as did all but one of the ‘mixed mode’ students. Learning outcomes and student responses to end-of-study questionnaires were analyzed.

B. Learning Outcomes

a. Exams. Three exams during the semester and one final exam were administered, as is the norm for that course. Each exam consisted of multiple choice, ranking and similar questions (60%) and an open-ended lab investigation done outside of class by collaborative ‘science teams’ of three or four students. Table I shows the comparison of the two groups.

TABLE I. Test scores for Regular and ‘Mixed-Mode’ students, F2005.

Students	Test 1	Test 2	Test 3	Final
Regular	85.3	80.6	78.5	80.8
Mixed Mode	88.0	75.2	83.5	85.5

b. FCI Test. A recognized leading indicator of conceptual understanding of basic physics material is the score a student attains on the Hestenes-Halloun “Force Concept Inventory” (FCI) test [31, 12, 32]. The Hake $\langle g \rangle$ [4] (or more directly, the modified $\langle g \rangle$ or Marx-Cummings $\langle c \rangle$) factor measures the *improvement* in physics understanding by examining the change in students’ scores on the FCI administered at the beginning (Pre) and at the end of the semester (Post). The Hake g factor is equal to: $100 \cdot (\text{post-pre}) / (\text{max-pre})$ where pre/post is the number of correct answers to the test given before/after material is covered and where max is the total number of correct answers on the test. The post test was administered near the end of the semester; Henderson [33] has determined that giving the FCI as a pre-test does not affect the post-test scores. The FCI test covers only motion and force material. The average for a group of students is indicated by brackets $\langle \rangle$. The modified Hake $\langle g \rangle$ was higher for the mixed mode students (0.42 compared to 0.21 for the ‘regular’ students and about 0.15 for ‘traditional’ students). FCI scores of a few students in both groups were omitted (hence the appellation ‘modified’) wherein the students were determined not to have fully participated when taking the post FCI (taken at the end of the semester when a ‘test’

that did not figure in their grade was given a low priority by them). Further studies are needed to determine if the striking difference in average Hake factor for the three groups is statistically significant. On the positive side, the two cohorts, selected chronologically and randomly, covered the same material by the same instructor, the only difference being the actual class time: one group in the physical lab and the other group in the virtual lab. Both groups, moreover, had access to the instructor after class hours. Both student cohorts improved their scores on the FCI, as is expected. The ‘Mixed Mode’ students (taking the ‘class’ part in the virtual laboratory) improved more, as is indicated by the different Hake $\langle g \rangle$ values.

An indication of the relative improvement of the two cohorts is shown in Table II, which shows the number of FCI questions where the fraction of correct answers of one cohort is higher than the fraction of correct answers for the other cohort, for both Pre- and Post-FCI tests. The ‘Mixed Mode’ or virtual modeling students performed better than the ‘regular’ or physical modeling students on both the Pre- and the Post-FCI tests in spite of the seemingly random selection process. However, the fact that undergraduates can sign up for a course before post baccalaureate students could have resulted in a cadre of

'late-signers' who are more mature and have greater motivation.

TABLE II. Improvement of two cohorts, Pre- to Post-FCI test.

Comparison	Regular Students	Mixed Mode Students
Number questions with higher fraction correct, Pre-FCI	0 (3 same)	27
Number questions with higher fraction correct, Post-FCI	0 (3 same)	27
Number questions where fraction of correct answers increased	27	25

C. Virtual tutorials, homework and conceptual quizzes

Faculty who deliver lectures have a difficult time knowing if students are paying attention or understanding what is being presented. Without due diligence, faculty using a variation of the Modeling method can sometimes be unaware of a given student's understanding, particularly if three or four students work in a group. A virtual environment such as LabPhysics, however, offers the advantage of recording all student transactions in an easily accessible database. This means, for example, that when a conceptual quiz is administered, faculty can determine how much of which tutorials the student has actually progressed through prior to the quiz, and how that student responded to various assessment or checkpoint questions. If an online homework grading system is also used, faculty can look at correlations between successful homework completion and grades on quizzes. The author gave typical homework assignments (about 10 per chapter in a standard introductory text book), and administered conceptual quizzes each week during the semester.

Quizzes were designed to stress basic concepts, with little emphasis on mathematical problem solving. The quizzes generally contained ranking questions [34], Mazur-type [35] questions or those relating to recent lab investigations and model-building.

Mixed mode students were not 'forced' to be current in their tutorial work, although they were 'forced' to be current in the homework which was automatically corrected online (via WebAssign) with built-in time cut-offs. With limited statistics, we are able to conclude that

students who did not complete tutorials on time but did complete homework on time, did noticeably more poorly on the quizzes than did those students who completed both homework and the tutorials on time. Successfully completing homework assignments does not correlate well with understanding of basic physics concepts. This result is consistent with the relative Hake <g> scores.

D. Student Perceptions

Each student in the two cohorts (physical and virtual labs) took the same test and final exam.

40% of each test and 50% of the final exam consisted of an open-ended laboratory investigation. A typical laboratory investigation is shown from Test 1, F2005:

Modeling

You are called upon to make a prototype of an amusement park ride. Your assignment is construct a series of ramps which will allow you have a cart behave in a way such that its motion, when released by the student, is similar to Graph A or B or C. In the classroom, students at Tables I & IV are assigned to experimentally produce Graph A, students at tables II & V are assigned to experimentally produce Graph B and students at Tables III and VI are assigned to experimentally produce Graph C. You may have to be creative in what you use for ramps. Feel free to use stuff here, get scrap lumber at your home, at Lowes/Home Depot, etc. Joining sections of ramps together for smooth transitions will need originality, as well.

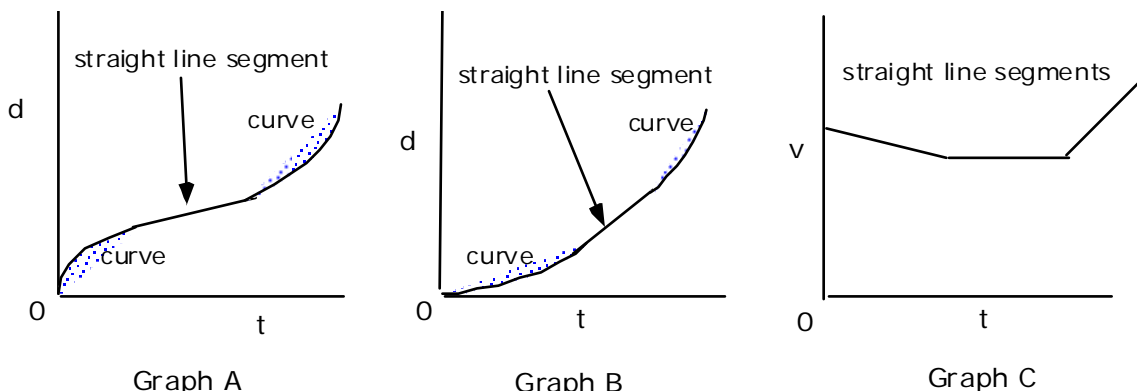

FIGURE 7. Students have to construct a combination of ramps so that the motion of low friction carts along the ramps will reproduce Graphs A, B and C.

You are also to make measurements on your constructed apparatus and show that the corresponding graphs are basically consistent with the graph assigned (see me if you have questions). Positive displacement is defined to be along the ramps in the direction of motion of the object. You are urged to discuss your experimental design with me before taking data. Such procedure may save you time and Tylenol.

Write-up using a word processor: include your names and lab station number, and the following format. Include, in this order, the purpose of the experiment, the physical set up (you must include drawings or schematics – the Draw Tool in word will help here, or you could use any other drawing software) - you may include a digital photo of your set-up, equipment used, the theoretical basis for your investigation, (that is, the theoretical model whose conclusion you are investigating or testing), procedure followed, data collected, graphs or equations used, analysis and conclusions. Label each section as indicated. Graphs should be done with Graphical Analysis, not by hand. You can Copy and the Paste them into a Word doc. from Graphical Analysis by using the Grab tool (HD->Applications->Grab). Always give estimates of random errors (be sure you know what that means). Systematic

errors should, of course, be eliminated before any experiment is 'published' or handed in to be graded. Staple all pages together. One report for each lab station. See me, as always, if you have any questions. Scientific ethics requires that all work with a collaborative project. If someone is not pulling her/his share, please let me know and I will have a 'chat' with the slothful offender. You will be emailing me a ranking of your group members: 1(did essentially no work) to 5 (worked a great deal) for each of your science group members. Please send me an email with that information.

a. Observations carried out over the course of a semester by both the instructor and an assistant indicated no discernible differences between the two groups in their ability to function efficiently and purposefully in the physical lab. The office of the instructor was 10 feet from the physical lab, providing him with continual observation throughout the time of the exam-related laboratory investigation (three or four days). Mixed Mode students were administered a questionnaire at the end of the fall semester. Completion of the questionnaire was not required for the course. Results from a question are shown in Figure 8.

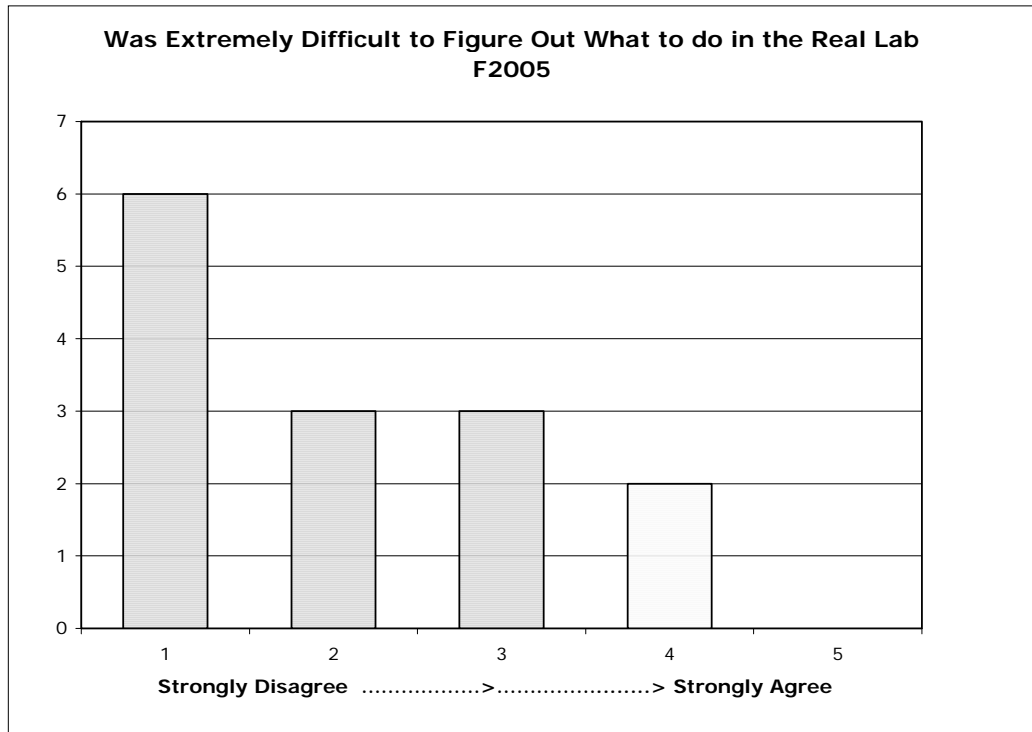

FIGURE 8. Response of mixed mode students to question regarding transferability of skills to physical lab.

b. Electric circuits were studied in the virtual lab during the spring, 2006. An exam was administered shortly thereafter that covered circuits and several other topics. The class had both 'Mixed Mode' and physical lab

students from the previous semester. After the students had received their corrected and graded exams, a questionnaire was administered, with results shown in Figures 9, 10 and 11.

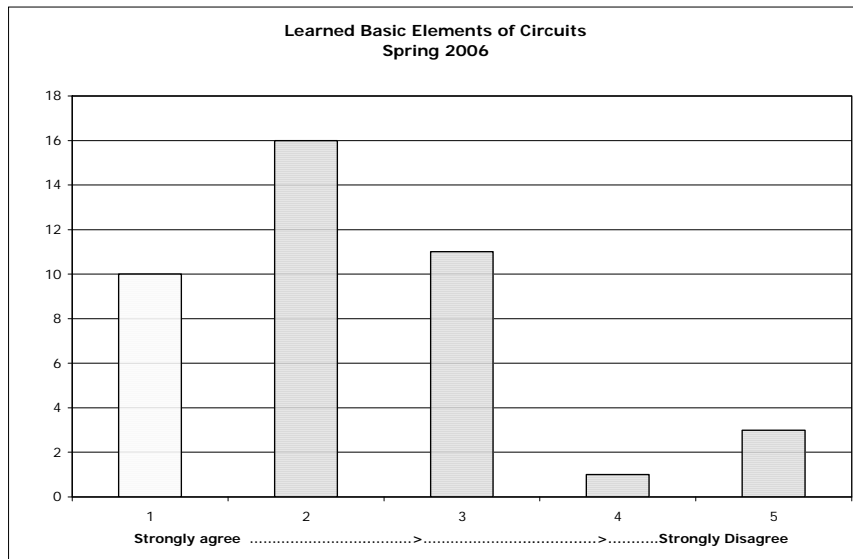

FIGURE 9. Student attitudes toward learning circuits in virtual laboratory.

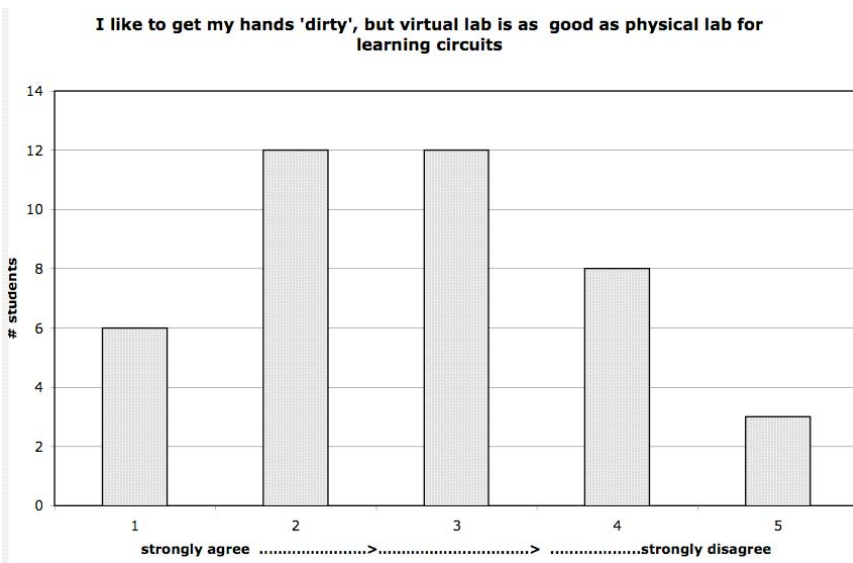

FIGURE 10. Student attitude regarding 'hands-on' aspect of virtual labs for learning circuits.

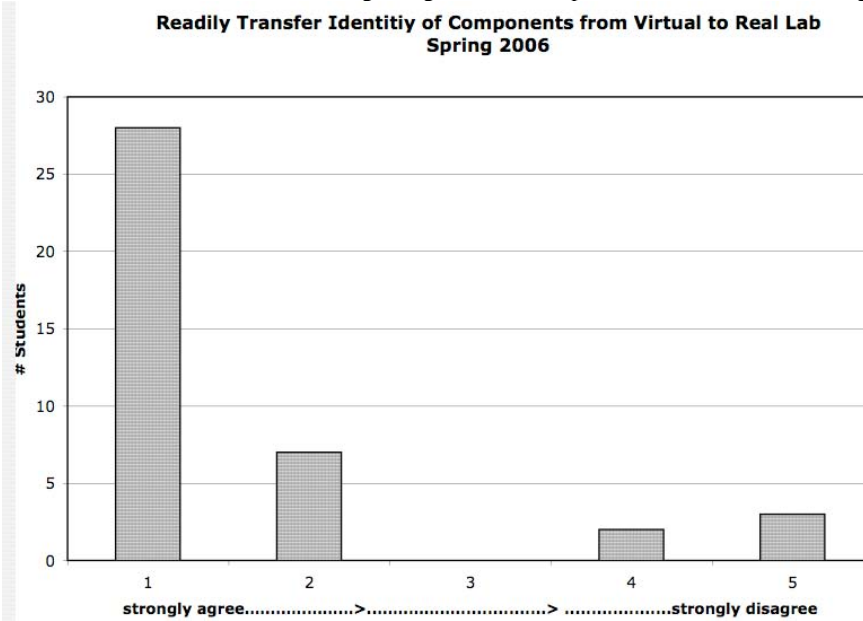

FIGURE 11. Student responses regarding transferability of physical knowledge of circuit elements in virtual world to physical world.

E. Student Opinions Concerning Learning in an Asynchronous Virtual Laboratory

The tactile and kinesthetic attributes of the best of laboratory experiences (*e. g.*, Modeling) cannot be duplicated in a virtual environment, and MIT's haptic feedback project [36] is in its infancy. Unfortunately, no more than 15% of today's students taking introductory physics in community or four-year institutions have an exemplary laboratory experience. Lack of equipment, 'cookie-cutter' labs of shrinking time periods, lack of adequately trained lab instructors, or lack of labs (economic reasons) are some of the reasons that both

students and faculty often rank introductory labs so poorly. Extensive collaboration among lab partners could be a positive force in physical lab settings, but time constraints and uncertain and variable contributions to semester grades make this more of a wish than a reality. The asynchronous nature of a virtual laboratory environment, with virtual peers offering both positive suggestions and illustrative misconceptions, partially overcome these problems. Mixed Mode students at the end of the fall semester, 2005 were asked their opinion about some of these issues. Figures 12 and 13 show some of their collective responses.

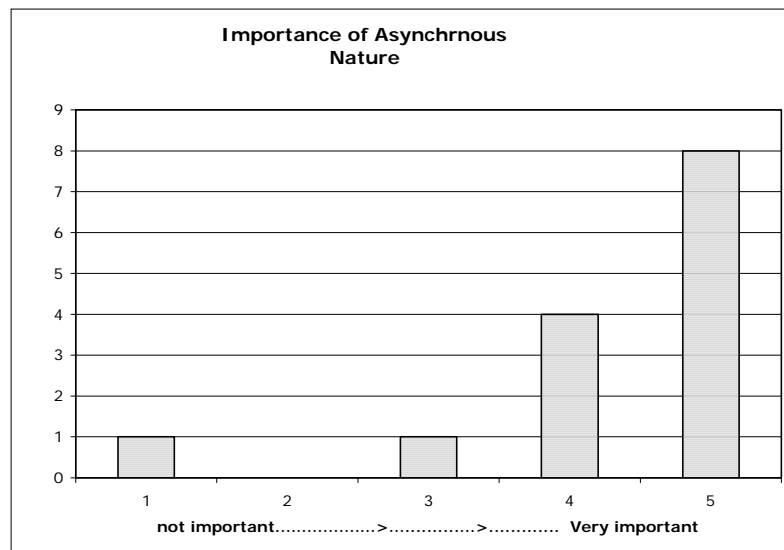

FIGURE 12. Mixed Mode students' ranking of the importance of the asynchronous nature of LabPhysics.

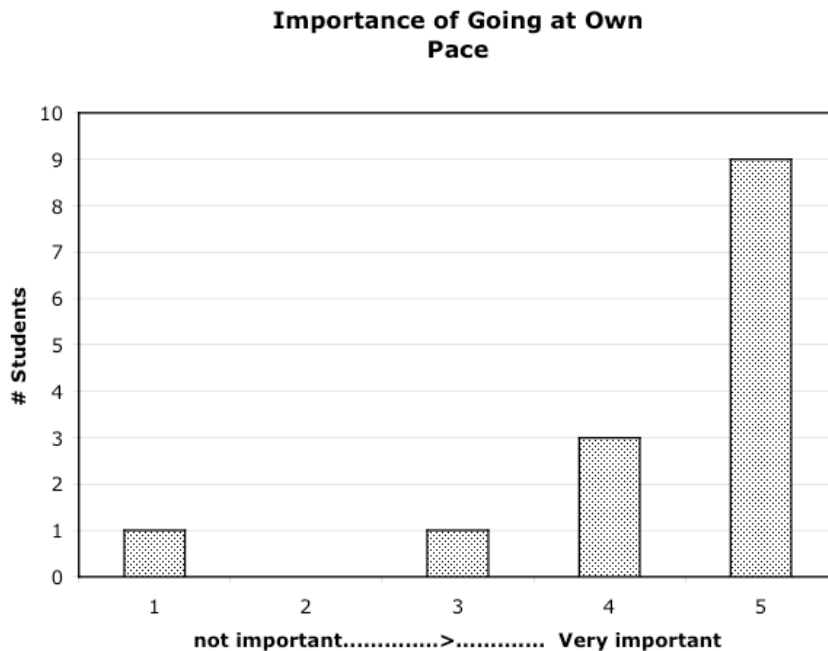

FIGURE 13. Ranking of Mixed Mode students of ability to go at own pace.

Figures 12 and 13 may suggest one reason that Mixed Mode students performed, on average, better than Regular students in the F2005. Many students in both cohorts worked between 10 and 30 hours a week and a number of them were post-baccalaureate students studying for standardized exams in their chosen professions. The ability to explore and conduct their investigations when (often at night) and where (usually at their residence) they wanted, *for as long as they wanted*, seems to be very important.

F. Exit Interview Comments

Students from the F2005 class as well as those from earlier field testing were encouraged to write a few sentences at the end of the semester/field test that encapsulated their impressions of LabPhysics. These comments were not read until after grades were turned in. What follows are representative comments.

- “This is just like being back in lab, Dr. M,” enthused one recent student tester of the LabPhysics Constant Velocity Module.
- AM: “..you get to see other students’ reasons for their answers..”
- DB: “..the lab gives you an explanation for all answers, right or wrong.”
- LH: “It was fun being able to play with the circuits.”
- CH disliked all science courses in HS – “...they were lectures, boring, not hands on (unlike English, where students got to *read* books, and were not merely *told* about books by teacher.” She pretty much ‘tunes out’ of lectures.
- LF: “A damn good idea.”

An insight into student interaction with virtual peers was provided by a female student from Sweden. Having taken several physics courses in the lecture format in her home country, she went through a number of tutorials or models of LabPhysics before enrolling in the second semester of the interactive laboratory-based class taught by one of the authors. She reported that she “knew exactly how to work with her science group members in a collaborative way”, even though she had never experienced that level of collaboration in her previous coursework. The reason she knew how to work with peers? - “..because I collaborated with my virtual peers in LabPhysics!”

VI. CONCLUSIONS

Students have demonstrated that they can learn both science content and laboratory skills in a guided virtual science laboratory environment. Insight into those viewpoints are provided using standardized tests and by questionnaires using the Likert scale as well as by open-ended voluntary exit responses.

1. The average modified $\langle g \rangle$ for the Mixed Mode students (0.41) compares with an average value of 0.15 for students taking a ‘traditional’ course.

2. More than 85% of the students indicated that they were easily able to transfer laboratory skills from the virtual lab to the physical lab. These results were consistent with the author’s (GWM) observations that the ‘mixed mode’ students successfully executed open-ended test and final exam questions which required students to devise, set up and carry out a laboratory investigation as part of tests throughout the semester. The issue of transferability of lab skills and familiarity with lab equipment is extremely important.

3. There is no statistical difference in semester grades between the two groups.

4. We have demonstrated to some extent that the cost barriers described by Karelis [37] are overcome since there need not be a faculty or other person ‘at the end of the internet connection or phone line’. 21 students took the semester mechanics course in the virtual lab; there is no physical limit to that number. For online courses to be truly cost efficient, there should be no limit to the number of students who can simultaneously use this approach – the marginal cost should approach zero as the number of students increases. To fully demonstrate those economics, a cadre of students would have to use the virtual lab environment completely separated, both physically and electronically, from an instructor. That situation is yet to occur.

5. Successful immersion (completion of tutorials) in a virtual and highly interactive environment is a better indication of conceptual understanding of physics principles than is completion of standard textbook homework examples.

Although limited by statistics, these results may be a significant test of the efficacy of student learning in a virtual environment, since:

- a) the two cadres of students had the same homework, quizzes and tests, and differed in terms of only one variable – the nature of the class: virtual versus physical lab environments;
- b) the ‘regular’ cadre of students were in a PER-inspired interactive laboratory setting as opposed to a lecture setting, affording a good comparison of the efficacy of the virtual environment system.

Clearly, more data is needed, but the measurement of student learning in a highly interactive, virtual lab-based physics course, when compared to average student learning taking courses by traditional means, is an important and encouraging data point for both the online learning and the general physics communities. While Hake asked if there was any learning taking place in distance education [6], he had previously shown that there was little increase in understanding of physics concepts taking place in the lecture classroom [4]. Results presented here indicate that learning physics in a virtual environment, driven by exemplary pedagogy, may be a viable alternative to the standard method of instruction.

REFERENCES

- [1] Karplus, R., *Science Teaching and the Development of Reasoning*, Journal of Research in Science Teaching **14**, 7 (1977).
- [2] Reif, F. and Larkin, J. H., *Cognition in scientific and everyday domains: Comparison and learning implications*, Journal of Research in Science Teaching **28**, 28 (1991).
- [3] Redish, E., *Implications of Cognitive Studies for Teaching Physics*, American Journal of Physics **62**, 8 (1994).
- [4] Hake, R., Survey of Test Data for Introductory Mechanics Courses, AAPT Summer Meeting, Notre Dame University, AAPT. **24**, 55 (1994).
- [5] McDermott, L., *Physics Education Research - The Key to Student Learning*, American Journal of Physics **69**, 1127-1137 (2001).
- [6] Hake, R., *Distance and Classroom Learning: Is There Any? ref 53 at* <http://www.physics.indiana.edu/~hake>, Indiana University: 21 (2007).
- [7] Heath, C. H. a. D., *Made to Stick: Why Some Ideas Survive and Others Die*, (Random House, New York, 2007).
- [8] Hestenes, D., Modeling Methodology for Physics Teachers, The changing role of the physics department in modern universities, College Park, MD, American Institute of Physics, (1996).
- [9] Atkin, J. M. and Karplus, R., *Theory or Invention?* Science Teacher **29**, 1 (1962).
- [10] Karplus, E. and Karplus, R., *Intellectual development beyond elementary school*, School Science and Mathematics **79**, 9 (1970).
- [11] Merrill, M. D., Li, Z. *et al.*, *Second Generation Instructional Design*, Educational Technology **30**, 8 (1990).
- [12] Hestenes, D., Wells, M. *et al.*, *Force Concept Inventory*, The Physics Teacher **30**, 141-158 (1992).
- [13] Piburn, M. D., Sawada, D. *et al.*, *Reformed Teaching Observation Protocol (RTOP) Reference Manual Tempe*, Arizona Board of Regents, (2000).
- [14] Lawson, A. E., Bloom, I. *et al.*, *Evaluating College Science and Mathematics Instruction*, Journal of College Science Teaching **31**, 6 (2002).
- [15] Allen, I. E. and Seaman, J., *Online Nation: Five Years of Growth in Online Learning*, Sloan Consortium (2007).
- [16] Christian, W. and Belloni, M., *Physlets: Teaching Physics with Interactive Curricular Material*, (Prentice Hall, Inc., Upper Saddle River, 2001).
- [17] Kiselev, S. and Yanovsky-Kiselev, T., *Interactive Math and Physics with Java*, from www.physics.uoguelph.ca/applets/intro_physics/kisalev, (2007).
- [18] Finkelstein, N. D., Adams, W. K. *et al.*, *When learning about the real world is better done virtually: A study of substituting computer simulations for laboratory equipment*, Phys. Rev. ST Phys. Educ. Res. **1**, 8 (2005).
- [19] Arons, A., *Guiding Insight and Inquiry in the Introductory Physics Laboratory*, The Physics Teacher **31**, 5 (1993).
- [20] Whitehead, A. N., *The Aims of Education*, (Macmillan, New York, 1929).
- [21] Boettcher, J., *Ten Core Principles for Designing Effective Learning Environments: Insights from Brain Research and Pedagogical Theory*, Innovate **Volume**, DOI (2007).
- [22] Hammer, D., *Two Approaches to Learning Physics*, The Physics Teacher **27**, 664-670 (1989).
- [23] Minstrell, J., *Facets of students' knowledge and relevant instruction in Research in Physics Learning: Theoretical Issues and Empirical Studies*, International Workshop, Bremen, Germany, (1991).
- [24] Viiri, J., *Multiple Representations in physics teaching and learning*, XV International Conference on New Directions in Physics Teaching, Benemérita Universidad Autónoma de Puebla, México (2007).
- [25] Minnesota, U., *University of Minnesota Physics Education Research and Development*, from <http://groups.physics.umn.edu/physed/>, (2008).
- [26] Van Heuvelen, A., *Experiment Problems for Introductory Physics Labs*, APS Spring Meeting, (1997).
- [27] Redish, E. and Steinberg, R., *Teaching Physics: Figuring Out What Works*, Physics Today **52**, 24-30 (1999).
- [28] Turner, M., *The Effect of Applying Principles of Reformed Teaching and Learning to an Asynchronous Online Environment on Student Cognition of Physics Concepts in Kinematics*, School of Education, Greensboro, NC, UNC Greensboro, Ph. D. 117 (2005).
- [29] Beichner, R., *Testing Student Interpretation of Kinematics Graphs*, American Journal of Physics **62**, 750-762 (1994).
- [30] Mzoughi, T., *Can LAAPhysics Be Used to Teach Introductory Physics Laboratory?*, AAPT Announcer **35**, 77 (2005).
- [31] Halloun, I. and Hestenes, D., *Initial Knowledge State of College Physics Students*, American Journal of Physics **53**, (1985).
- [32] Huffman, D. and Heller, P., *What Does the Force Concept Inventory Actually Measure?*, The Physics Teacher **33**, 6 (1995).
- [33] Henderson, C., *Common Concerns About the Force Concept Inventory*, The Physics Teacher **40**, 6 (2002).
- [34] O'Kuma, T., Maloney, D. *et al.*, *Ranking Task Exercises in Physics*, (Prentice Hall, Upper Saddle River, New Jersey, 2000).
- [35] Mazur, E., *Peer Instruction*, (Prentice Hall Series in Educational Innovation, Prentice Hall, Inc., Upper Saddle River, 1997).
- [36] Thompson, E., MIT and London team report first transatlantic touch, **Volume**, DOI (2002).
- [37] Karelis, C., *Education Technology and Cost Control: Four Models*, Syllabus **12**, 20-28 (1999).
- [38] Bork, A. and Gunnarsdottir, S., *Tutorial Distance Learning: Rebuilding Our Educational System*, (Kluwer Academic Systems, New York, 2001).
- [39] Meisner, G. W. and Hoffman, H., *Changing Online Paradigms: Beyond Information Transmission 'Lectures' To Research-*, (2003).
- [40] Pellegrino, J., Hickey, D., Heath, A., Rewey, K., Vye, N., *Assessing the Outcome of an Innovative Instructional*

Gerald W. Meisner, Harol Hoffman, Mike Turner
Program. Technology Report No. 91-1, The Vanderbilt
Learning Technology Center. Nashville, TN, (1991).

[41] MIT. "MIT Open CourseWare." from
<http://ocw.mit.edu/OcwWeb/hs/home/home/index.html>