

AGAINST v P-PIED PIPING AS A WAY TO DERIVE HEAD-FINAL STRUCTURES

CONCHA CASTILLO ORIHUELA
Universidad de Málaga

Abstract

This paper provides two arguments against v P-pied piping as an appropriate mechanism to derive head-final structures; on the one hand, arguing that floating quantifier structures in an OV language like German give evidence that S(ubject) must raise (i.e. merge internally) on its own in Spec,T, and not as part of v P; on the other hand, the trigger of the internal merge of S in Spec,T cannot seem to be accommodated to the full v P. The present work is part of a wider research project in which I contend that S is the first constituent to be processed and linearised in both head-initial (SVO/SAuxVO) structures and head-final (SOV/SOVAux) structures, in accord with the claims in the recent work of Antisymmetry theory by Kayne (2011/2013). In this paper, I suggest that the derivation of head-final structures from head-initial structures be accomplished through remnant movement of VP and v P to a lower Spec of v and T, respectively (aside from the more simple movement of O to a lower Spec of v).

Keywords: head-initial SVO/SAuxVO structures, head-final SOV/SOVAux structures, Antisymmetry theory, Merge & Agree framework, v P-pied piping, floating quantifier structures, trigger of movement to Spec,T, remnant movement of VP and v P.

Resumen

En este artículo intento demostrar que el mecanismo conocido como v P-pied piping o ‘movimiento de atracción de Fv’ no es un mecanismo adecuado para derivar estructuras de núcleo final. Utilizo para ello dos tipos de argumento: por una parte, defendiendo el hecho de que las estructuras de cuantificador flotante en una lengua OV como el alemán parecen demostrar que el Sujeto debe elevarse (esto es, fusionarse internamente) a la posición de Especificador de T de forma independiente, y no como parte integrante de Fv; por otra parte, arguyo que el desencadenante de la citada fusión interna en el Especificador de T no puede corresponder a Fv en su totalidad. El trabajo es parte de un proyecto de investigación más amplio en el que defiendo que el Sujeto es el primer constituyente que es procesado y linealizado en la secuencia lingüística, tanto en estructuras de núcleo inicial (SVO/SAuxVO) como en estructuras de núcleo final (SOV/SOVAux), hipótesis que estaría en consonancia con los postulados básicos de la teoría de la Antisimetría del trabajo de Kayne (2011/2013). En el presente artículo, analizo la posibilidad de que la derivación de estructuras de núcleo final a partir de estructuras de núcleo inicial se lleve a cabo mediante el movimiento de remanente de FV y Fv a una segunda posición de Especificador de v y de T, respectivamente (al margen del movimiento más básico de O a un segundo Especificador de v).

Palabras clave: estructuras de núcleo inicial SVO/SAuxVO, estructuras de núcleo final SOV/SOVAux, teoría de la Antisimetría, modelo *Merge & Agree*, movimiento de atracción de Fv,

Received 13/01/16 – Accepted 02/05/16

estructuras de cuantificador flotante, desencadenante del movimiento a *Spec,T*, movimiento remanente de *FV* y *Fv*.

1. INTRODUCTION

This paper is part of wider research conducted by the author on the derivation of head-final structures from head-initial structures within a minimalist model of grammar. This model is based on the assumption that core syntax consists of the operations *Merge* and *Agree* (Chomsky 1995, 2000, 2001 *et seq.*). This paper analyses such operations, and also crucially the subsequent operation of *Transfer to Spell-Out*, in accord with the precepts of Antisymmetry theory (Kayne 1994). As is well known, in contrast with Antisymmetry theory, the *bare phrase structure* construct postulated by Chomsky (1995) straightforwardly ignores order as an algorithm of core syntax. A central postulate of Antisymmetry theory (very possibly the one upholding the overall theory) is that there is a base order in natural language, namely *Spec-head-complement*, and that therefore head-final structures (that is, structures featuring the order complement-head) derive from head-initial structures (that is, structures featuring the above-cited head-complement order). Very importantly, Kayne's latest work (2011/2013) on Antisymmetry makes a claim that can be identified as an economy principle in regard to how the derivation of a linguistic structure is expected to proceed, which asserts that production (or the same, linearisation) follows the way of processing (or *Agree*), that is, from left to right. Based on the cited principles or ideas (that is, the *Spec-head-complement* order, and production and processing sharing the same order/direction from left to right), I am now in the process of developing an approach to head-initial (*SVO/SAuxVO*) and head-final (*SOV/SOVAux*) structures that advances two basic claims: first, that *S*(ubject) is the first unit of *Spell-Out*, that is, the first constituent to be processed and subsequently linearised, in both head-initial and head-final structures, and second, that head-initial structures (*VO/AuxVO*) are the result of a minimal delay between *Merge* and *Agree*, whereas head-final structures (*OV/OVAux*) are the result of a delay between *Agree* and *Transfer to Spell-Out*, necessarily more costly.

Most of the discussion in the present paper is in support of the first of the two claims. Specifically, I focus on the rejection of *vP*-pied piping as a proper mechanism to derive head-final structures, against an important trend in the current literature that makes use of this kind of movement of *vP* to *Spec,T* (see e.g. Hinterhölzl 1999; Pearson 1999; Haegeman 2000; or also, very notably, Biberauer and Roberts 2008). The connection between *vP*-pied piping and the above-cited claim that *S* is the first constituent to be processed and linearised lies of course in the fact that *vP*-pied piping entails that *S* does not raise on its

own to Spec,T (against my general claim) but that it does so with the remaining constituents of the *v*P. Incidentally, I would like to note that *v*P-pied piping, frequently characterised in the literature as a *massive* kind of movement, has been criticised precisely because of its complexity (see e.g. Richards (2008) or the comments in Roberts (2007: 196)). The technicalities of the movement, which is perfectly upwards and cyclic, are nevertheless impeccable.

In section 2 immediately below I introduce relevant principles of Antisymmetry theory, and the types of movement postulated in the general literature to derive head-final structures from head-initial ones, and in sections 3–3.2 I argue that the above-mentioned *v*P-pied piping movement, is not appropriate to generate head-final structures. Finally, in section 4, I sketch out the model of derivation that belongs to a work in progress (see above), in which I demonstrate in a comprehensive way the claim in Kayne (2011/2013) that linearisation goes the way of processing.

2. ANTISYMMETRY AND THE DERIVATION OF HEAD-FINAL STRUCTURES

It is well known that all six possible combinations of S(ubject), V(erb), and O(bject) are available as canonical surface word orders cross-linguistically, being by far SVO and SOV the two most widely-spread. Together with SVO, SAuxVO represents the typical head-initial structure, and likewise SOV and SOVAux stand for the typical head-final structures.¹

- | | |
|---|----------------------------------|
| (1) a. Peter read the book | SVO (Modern English) |
| b. ...weil Peter das buch las | SOV (Modern German) ² |
| since Peter the book read | |
| c. Peter might read the book | SAuxVO (Modern English) |
| d. ...gif heo þæt bysmor forberan wolde | SOVAux (Old English) |
| if she that disgrace tolerate would | |

¹ Specifically, both SAuxVO and SOVAux are referred to in the literature as *harmonic word orders* since in both the heads (that is, Aux and V) occupy the lefthand side or the righthand side of their respective complements (that is, V and O). By contrast, an order like e.g. SAuxOV is defined as *non-harmonic*, since the Aux head is located to the left of V while the V head occupies the righthand side of its complement, O.

² The Modern German example in (1b) is that of a subordinate clause since, as is widely-known, German main clauses are V2, and therefore the finite verb occupies in these the C head, rather than the T head, as in the structures under analysis in this paper. As for the Old English illustration in (1d), a subordinate clause has been chosen again because of the controversy in the literature as to whether the language is V2 or non-V2 regarding main clauses.

“if she would tolerate that disgrace”

((1d) Taylor and Pintzuk 2012: 29)

According to Antisymmetry theory (Kayne 1994), whose central postulate is that Spec-head-complement is the basic word order of natural language, head-final structures are logically derived from head-initial structures. Antisymmetry theory contends that linear order is the result of relations of asymmetric c-command, which also shape phrase structure, and comes to oppose the GB theory known as the Head parameter (Stowell 1981; Travis 1984) for which a given head can either precede or follow its complement at the base. More specifically, within Antisymmetry theory the so-called Linear Corresponding Axiom (LCA) establishes that the Spec-head-complement order results without exception from the condition that if an element α c-commands an element β (that is, if β is dominated by a sister of α) then β may not c-command α in the phrase-marker. As stated in (2), the cited relation of asymmetric c-command is also postulated to be one of precedence rather than subsequence. Kayne (1994) defends this claim based on the empirical observation that specifiers typically precede their heads.

- (2) The universal base order Spec-head-comp is a consequence of:
- a) asymmetric c-command relations between constituents
 - b) relations in a. being ones of precedence

Though Specifiers typically precede their heads, as just mentioned, the same does not hold for the relation between heads and complements, and the order OV is as frequent as VO. Positing the sequence where V precedes O (that is, V>O) as the base order was thus criticised in the first decade of Antisymmetry or LCA theory for being speculative: since the head and its complement are sisters in phrase structure, then they c-command each other, with the result being that any of the two could precede the other. This controversial issue is apparently resolved in Kayne’s (2011/2013) claim that production (or the same, linearisation) goes the same way as processing, exactly from left to right: see (3) below for the original wording. I would thus like to argue that, in the case that a verb selects its complement, and if (3) is assumed, then it follows that the verb must precede the complement (hence V>O as the basic order).

- (3) Probe-goal search shares the directionality of parsing and of production
 →(=therefore)

Probe-goal search proceeds from left to right

(Kayne 2011: 12)

Incidentally, Kayne (2011/2013) also provides theoretical support for the order of precedence between Specifiers and their heads, which had earlier been defended from an empirical perspective through resort to massive frequency of use (see above). The author argues that the order Spec>head is the result of the head having already taken a complement to its right: the only possibility is therefore for the Specifier to occupy the position to the left of the head.³

Focusing on the issue of the derivation of head-final structures from head-initial structures, the first thing to note is that this is basically regulated by the principle of Antisymmetry or LCA theory in (4), which is supported by empirical data from a multiple set of languages in Kayne (1994, 1998, 2011/2013).

- (4) Movement in linguistic structure is typically leftwards

Specifically, SOV structures are argued to derive from SVO from the inception of Antisymmetry theory (Kayne 1994 and also immediately later and very notably, Zwart 1997) through resort to movement of O. The tree-diagram configuration in (5b) shows such a movement in simplified form. In contrast with (5b), (6b) reflects an OV base order that is in accord with the Head parameter: as observed above in this section, the latter theory holds that the head V can be parametrised to either precede or follow its object. For the sake of simplicity, I ignore here the little *v* projection on top of VP, and likewise for simplicity, subjects figure in the Spec of T with no reflection of movement from within the verb phrase to the cited Spec, T position.

³ As for Abels and Neeleman (2009), the authors claim that the order Spec>head is the result of movement being typically leftwards (see (4)): in effect, given that movement is typically to the left and that subjects move from one Specifier position (within the verbal phrase) to another (the Spec of T), then Specifiers in general are expected to be located to the left of the corresponding element.

(5) a. Peter read the book

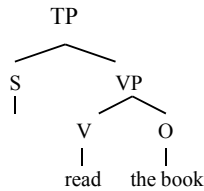

LCA theory: SVO

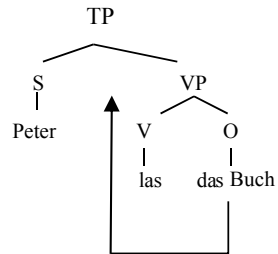
b. ...weil Peter das Buch las
since Peter the book read

LCA theory: SOV

(6) a. Peter read the book

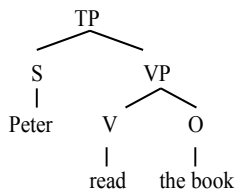

Head Parameter theory: SVO

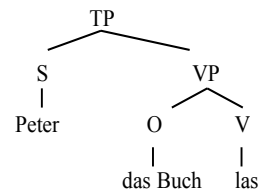
b. ...weil Peter das Buch las
since Peter the book read

Head Parameter theory: SOV

Before continuing with the account of head-final structures as deriving from head-initial structures, it is appropriate to note that Head parameter theory is, of course, not the only strand in the literature that opposes such a view. The work of van Kemenade (1987) inaugurates the view within generative theory that head-initial structures can derive from head-final ones by analysing Old English as such OV language at the base. In this respect, Taraldsen (2000) is one of the many works in the literature analysing Germanic languages in general as OV at the base, from which VO languages are built up by raising the verb to the left of the object. As for Jayaseelan (2010), the author extends such a view to all languages in general, contending that there are specific morphological reasons that may provoke the movement of the verb over the object, thereby resulting in VO languages.

Turning to the focus of the paper, a typical way to analyse an OV sequence in accord with Antisymmetry theory as derived from VO in the first years of minimalist theory (see again the connection between (5b) and (5a)) is through

resort to the covert vs. overt movement of O to the Spec position of a so-called AgrO projection on top of VP, with the trigger being the checking of Case (so-called checking theory of Chomsky 1993). Hence, it is postulated that an OV language checks accusative Case in an overt way whereas a VO language does so covertly (e.g. the discussion in Haegeman 2000). Incidentally, agreement projections disappear generally speaking from the theory (both AgrS and AgrO), and the above-mentioned movement to Spec,AgrO is replaced by movement to a Spec position of V. The movement of O to a Spec position of the verbal phrase would be justified on the grounds of accusative Case licensing. Very importantly, the possibility that O licenses its accusative Case in situ, that is in the sister position to V, is enhanced in Chomsky's framework (2000, 2001 *et seq.*) with the result being that the above-mentioned Spec position can be used to satisfy an EPP feature of the verb itself (see also Section 4 of the paper).

Crucially, a verb phrase can of course contain manifold constituents other than O. In order to avoid having to raise these constituents one by one before the verb, it is postulated in the literature (see originally in Hinterhölzl (1999) or Pearson (1999)) that the verb phrase moves in full. Furthermore, given that S(subject) is base-generated inside the verb phrase, more specifically in Spec,V initially in the theory and later on, when the *v*P-shell projection is postulated on top of VP, in Spec of the little *v* head, then moving the full verbal phrase can actually entail moving S as part of the cited verbal phrase. The target of movement is of course the Spec position of T.

Exactly whether S is moved to Spec,T as part of *v*P or not depends on whether the T head is occupied, either by V (in those languages featuring so-called V-to-T movement) or by Aux (in those languages where Aux is merged externally in T, or moved to that position).⁴ Thus, if V is in T in an SOV structure, or similarly Aux is in T in an SOVAux structure, then the *v*P [SO] and the *v*P [SOV] respectively will arguably raise to Spec,T instead of having just S raise to that position on its own. This is how the analysis of head-final structures is typically understood in LCA works like those of Hinterhölzl (1999), Haegeman (2000), or in Biberauer and Roberts' (2008) account of syntax in Old English. The label *v*P-pied piping actually refers to a certain way of justifying or explaining the movement of *v*P to Spec,T. I deal with the mechanics of *v*P-pied piping in the section below. Before dealing with this, I specify in (7) the three types of movement or internal Merge, in current minimalist terms, that are

⁴ It is well known that Chomsky (1995, 2001) comes to reject the view that the movement of V to the T head is a syntactic movement proper, as had been contended previously in GB theory, and analyses it as a P(honological)F(orm) phenomenon. Also, there is lack of consensus in the literature on reliable tests to diagnose V-to-T. Nevertheless, the view that V-to-T applies in core syntax is held in manifold works in the literature. The reader is referred to the evaluation chapter by Roberts (2011).

assumed in the general literature to be involved in the derivation of SOV and SOVAux: that is, I specify the movements implicated in the derivation of a sequence like (5b): namely, movement of O, movement of VP, or otherwise movement of ν P. The notation *_O_* means that the verb phrase contains more than one object and/or adjunct.

In addition, the movement affecting each one of the constituents (S, Aux, V, and O) or their combination is shown informally with arrows in the labelled-bracketing structure.

(7) a. SOV (with no V-to-T): movement of O to Spec, ν

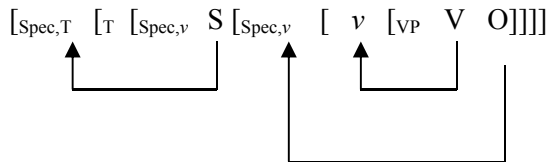

b. S_O_V (with no V-to-T): movement of VP to Spec, ν

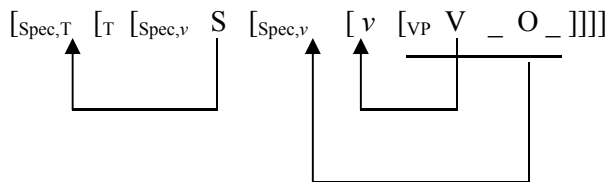

c. SOVAux: movement of ν P to Spec,T⁵

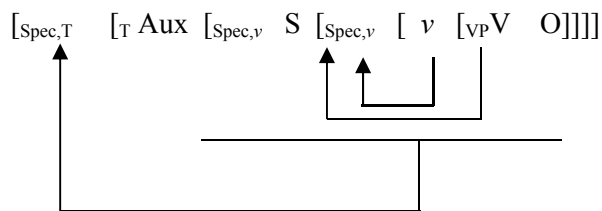

⁵ I have opted here and in (7d) for merging the auxiliary externally in T. Other options, which would not affect the core configuration, would be for the auxiliary to merge in T from an Aux node, or otherwise to remain in an Aux node or even a ν node on top of the ν projection of the lexical verb.

d. S_O_VAux : movement of VP to Spec,v and movement of vP to Spec,T

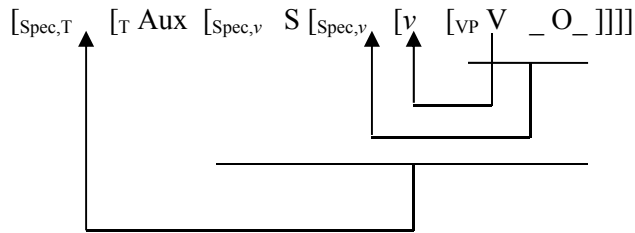

e. SOV (with V-to-T movement): movement of vP to Spec,T

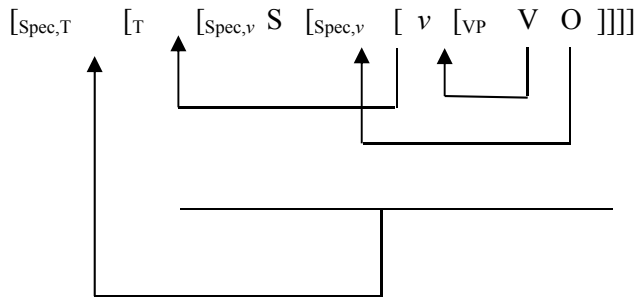

f. S_O_V (with V-to-T movement): movement of VP to Spec,v and movement of vP to Spec,T

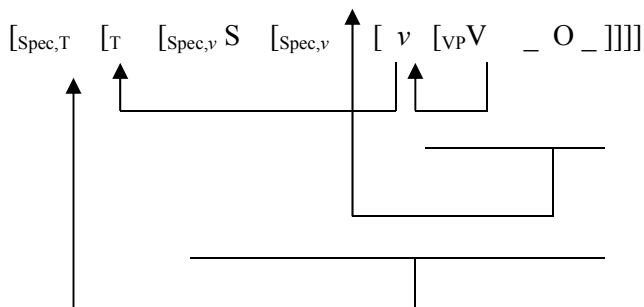

Except for the configurations in (7a) and (7c), in all other cases the roll-up movements of the constituents in the verb phrase entail what is known as

remnant movement. Thus, in (7b), (7d), and (7f) there is remnant movement of VP: since V is part of the VP, but V raises to *v*, then it is the VP except for V itself that goes up into Spec,*v*. As for (7e), both remnant movement of VP and of *v*P apply here: that is, VP goes up into Spec,*v* except for V (as in (7b,e)), and then *v*P raises to Spec,T but without *v*.

However, I would like to focus on another aspect of the labelled-bracketing configurations in (7) for the remainder of this section, and in sections 3–3.2 of the paper. The aspect I am referring to is the movement of *v*P to Spec,T, which features in configurations (7c, d, e, f). As observed in the section above, such a movement is typically justified as *vP-pied piping* movement, the core idea here being that instead of S(subject) moving on its own to Spec,T, it attracts with it the full *v*P constituent that S itself belongs within originally. This analysis is of course based upon a parallelism with e.g. *wh*-structures featuring a preposition in a language like English: the same as (8b) is accounted for by saying that the *wh*-element pied-pipes with it the full PP to the Spec,C position, so in a structure like e.g. (7c), S would be considered to pied-pipe with it the full *v*P.

- (8) a. [[Who]_i [have they worked for [t_i]]]?
 b. [[For whom]_i [have they worked [t_i]]]?

The derivation of a sequence like the above-mentioned (7c) is shown in the tree-diagram below. The example chosen for illustration is the Old English sentence in (1d) above.

- (9) ...gif heo þæt bysmor forberan wolde

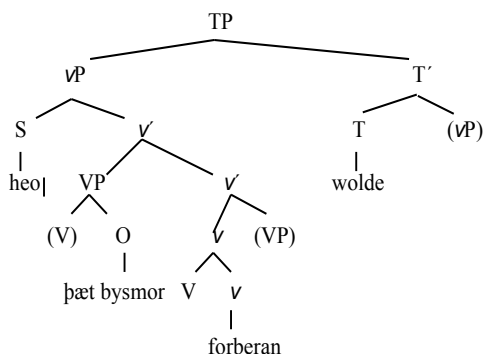

As observed in section 1 above, my research on the processing and linearisation of head-final vs. head-initial structures is guided by the claim in (3) above, repeated here with the same numeration. Importantly, it is clear that structures where a portion like [SOV] or [S_O_V], or one like [SO] or [S_O_] (see (7c, d, e, f) above), features in initial position do not abide by (3).

(3) Probe-goal search shares the directionality of parsing and of production
 →(=therefore)

Probe-goal search proceeds from left to right

(Kayne 2011: 12)

In effect, (3) cannot be reconciled with any of the labelled-bracketing configurations in (7c, d, e, f), which configurations require that the chunks or portions cited be processed as one constituent. Taking for example an SOVAux structure, the valuation of features for each of the constituents in the [SOV] portion would be expected to take place as the result of their raising to Spec,T, which does not seem to be possible at all. For one, the [perfective] feature that V would have to value against Aux cannot be argued to depend upon V moving to Spec,T in order to be adjacent to Aux (which would occupy T), since typical languages featuring SOVAux sequences (like German or Old English) also feature sequences like SAuxOV, where V is not adjacent to T.

However, my criticism of the labelled-bracketing configurations in the above-mentioned (7c, d, e, f), which are accounted for in the standard literature as *v*P-pied piping structures, does not lie in their clashing with a claim or principle like that of (3), since (3) must be shown to be an explanatory principle on its own. My aim in this part of the paper is, rather, to provide independent arguments that *v*P-pied piping is not an appropriate mechanism to derive head-final structures. I do this in section 3 below. Later, in section 4, I provide a sketch of a derivation of head-final structures where S(ubject) does not move to Spec,T together with the other constituents in *v*P, but instead it does so on its own, an account that is in accord with the claim or principle in (3).

And, together with *v*P-pied piping, VP-pied piping must be mentioned, since it would similarly be a way of explaining the movement of a macro-constituent, specifically VP, instead of an ordinary constituent (O), to Spec,*v* – see the structures in (7b, d, f) above. As I explain in section 4 of the paper, I endorse the technique of VP-pied piping: that is, for the VP itself to move to Spec,*v*, but not the kind of trigger that it entails in which O attracts with it the rest of the constituents in VP.

In relation to VP-pied piping, and before putting an end to this section, I would like to mention that a work like Svenonius (2007) presents a VP-pied piping analysis of OVAux sequences for a language like e.g. German arguing that V raises to the Spec position of Aux because of the licensing relation expected to apply between an auxiliary and the lexical verb it selects, and that it (V itself) pied pipes with it O or any adjunct originally within the VP. A weak point of the overall analysis is that it does not seem applicable to OV sequences in that it does not seem to explain head-finality in the absence of an auxiliary.

3. THE PRESENT PROPOSAL: ARGUMENTS AGAINST *vP*-PIED PIPING

I would like to base the rejection of *vP*-pied piping as a way of deriving head-final structures upon two arguments: on the one hand, it does not fit the syntax of floating quantifiers and, on the other hand, it cannot explain the trigger of movement to Spec,T. I deal with each one of these two aspects in sections 3.1 and 3.2 immediately below.

3.1 The floating quantifier argument

The phenomenon of so-called *floating quantifiers* is illustrated in (10) below for a head-initial language like English.

- (10) a. All the students have read the book
 b. The students have all read the book
 c. [... have [_{VP}[_{QP}all [_{DP}the students]]] read the book]]
 c.' [_{TP}the students_i have [_{VP}[_{QP}all [_{DP}t_i]]] read the book]]

A floating quantifier is a quantifier that is not adjacent to the DP with which it makes up a phrase, an analysis originally postulated by Sportiche (1988) and later developed in the work of Cardinaletti and Giusti (1989) or Shlonsky (1991). In broad terms, a floating quantifier construction like (10b) can plausibly be argued to be the result of the movement of the DP that is in the position of the complement of the QP headed by *all*. The full QP originally occupies the position of subject in Spec,_v, and then, either the full QP raises to Spec,T, as in (10a), or just the DP, as in (10b), thereby leaving the quantifier stranded.

The cited analysis of floating quantifiers was actually substantiated at the time of GB theory as proof for the VP-internal subject hypothesis, and came to

answer many dilemmas posed by a prior analysis that took the quantifier as a kind of adverbial. It must be said, however, that both types of accounts have gone on in the linguistic literature in general, and that there are still quite a number of issues today that are open to debate in the floating quantifier paradigm: for instance, the differences in grammaticality of structures exhibiting a quantifier in the Spec of an auxiliary (cf. *?The students all have done their work* vs. *The students might all have done their work*), or the fact that only pronouns appear to be able to occupy the Spec position of the QP (cf. *They all have read the book* vs. *?The students all have read the book; He wants them all* vs. **He wants the books all*).

The above issues are nevertheless out of the scope of the present discussion, which is focused on whether the movement of the DP complement of Q as in (10b) is significant at all for the theory of the derivation of head-final structures out of head-initial structures. The answer that I would like to put forward is that floating quantifier constructions in subordinate structures of a head-final language like German clearly appear to indicate that the DP complement of the quantifier raises on its own to the position of Spec,T, thereby making it impossible for *v*P-pied piping to apply.

Now, the structures in (11) correspond to main clauses in German which have, as is well known, V2 status. They thus differ from the English structures in (10) above not only in the OV order, which is now irrelevant, but also in the fact that the finite auxiliary *haben* ‘have’ occupies the C position, and the DP complement of the stranded quantifier (as in (11b)) occupies the Spec,C position, rather than Spec,T: see (11b’). Precisely because the eventual positions of internal merge (or movement) in this small paradigm are Spec,C and C, the movement of the DP complement away from the quantifier in (11b) does not contradict any possible operation of *v*P-pied piping, since such an operation could in any case have applied prior to the movement of DP to Spec,C. That is, in accord with a *v*P-pied piping account, before the movement to the C projection, the chunk or portion [SOV] *alle die Studenten das Buch gelesen* would have moved to the Spec,T position, which is actually the very *v*P-pied piping configuration, and the auxiliary *haben* would have moved to T. Subsequently, the auxiliary moves to C, and the complement of the quantifier moves to Spec,C.

(11) a. Alle die Studenten haben das Buch gelesen

all the students have the book read

a.´ [CP[Spec,Calle die Studenten_x] [Chaben_v]] [TP[Spec,T[t_x]das Buch
gelesen]_h [Tt_v] [AuxPt_v][vP t_h...]]

- b. Die Studenten haben alle das Buch gelesen
 the students have all the book read
- b.´ [CP[Spec,Cdie Studenten_i [Chaben_v][TP[Spec,Talle [t_i] das Buch gelesen]_h [Tt_v] [AuxPt_v] [vPt_h...]]]

This way, the V2 status of main clauses in German makes it impossible to acknowledge whether vP-pied piping can indeed be the case or not. Nevertheless, the situation in subordinate structures is completely different.

- (12) a. ...dass alle die Studenten das Buch gelesen haben
 that all the students the book read have
- a.´ [TP[Spec,T[alle die Studenten]_i [das Buch gelesen]_h] [T] [AuxP[Spec,Auxt_i [Spec,Auxt_h [Auxhaben] [vP t_i t_h...]]]]]
- a.´´ [TP[Spec,Talle die Studenten]_i] [T] [AuxP[[Spec,Auxt_i][Spec,Auxdas Buch gelesen]_h [Auxhaben [vP t_i t_h]]]]]
- b. ... dass die Studenten alle das Buch gelesen haben
 that the students all the book read have
- b.´ [TP[Spec,Tdie Studenten]_i] [T] [AuxP[Spec,Auxalle [t_i][Spec,Auxdas Buch gelesen]_h [Auxhaben [vP t_i t_h]]]]]

In effect, subordinate clauses in German are not V2 though they are still head-final structures: that is, not only does the object precede the verb (OV) but the non-finite verb also precedes the finite auxiliary (VAux), in the case, of course, that the structure contains an auxiliary. Now, a vP-pied piping analysis of (12a) would be as in (12a´): as shown, the chunk or portion [SOV], which is actually a vP made up of *alle die Studenten* and *das Buch gelesen* would move to Spec,T, the previous position for the respective constituents being a Spec of Aux. However, the fact that the DP is to the left of the quantifier in (12b) means that the latter is stranded – or, more properly, floating – in a separate projection, which in turn means that it has not been the case that the full vP has been pied piped, but that only the DP (that is, S(ubject), or rather part of S(ubject)) has raised on its own to Spec,T. The configuration that I would like to defend for (12a) is therefore (12a´´) which shows that only *S alle die Studenten*, and not the [OV] portion, moves or merges internally in Spec,T. Incidentally, it must be noted that, though the auxiliary *haben* is treated in (12) as an Aux head that does not move, it could be treated as well as a *v* on top of the vP that is headed by the past participle *gelesen*, and similarly, could be treated as an element raising to the T head (see note 5 above). In the case that the *v* option is taken,

the analysis would be identical to the one shown in (12a') and (12a''). Whereas, in the case that it is postulated that *haben* raises to T, then, instead of two Spec of Aux positions, there would be two Spec of T positions, but the core analysis would hold.⁶

All in all then, by contrast with (11) where *v*P-pied piping is a possibility, the subordinate structure in (12b) does indicate that *v*P-pied piping is not the case.

3.2 The trigger of movement argument

The second argument that I would like to provide against *v*P-pied piping is that none of the triggers that can arguably be postulated for the raising or internal merge of S(ubject) in Spec,T are applicable to a structure like a full *v*P. As observed in Section 2 above, the rationale supporting the mechanism of *v*P-pied piping is arguably that the trigger that causes the internal merge of S in the Spec position of T can serve for S to attract with it all the other constituents that make up *v*P.

The seminal framework of Chomsky (1995, 2000, 2001 *et seq.*) analyses derivations purporting that they consist of the operation of structure building or *Merge* and the operation of feature licensing or *Agree*, which is in turn followed by the operation *Transfer*, both to the phonological component (or *Spell-Out*) and to the semantic component. Specifically, the operation *Agree* consists in the licensing of formal features between a *Probe* and a *Goal*, the latter being c-commanded by the former. The licensing of features entails the movement or internal merge of the *Goal* in case the *Probe* has an EPP property; otherwise, *Agree* between *Probe* and *Goal* takes place in situ. As for the licensing of features itself, this hinges around the properties or concepts of feature valuation and feature interpretation.

Now, S(ubject) is a canonical *Goal* for T (in head-initial structures) which explains the typical position in which S is linearised (that is, the position it occupies at *Spell-Out*): namely, Spec,T. A different matter, however, is exactly what features of T with an EPP property are responsible for the displacement or internal merge of S from Spec, *v* up into Spec,T. Roughly speaking, there are three different candidates that have been put forward in seminal works in the literature for T's probing of S: ϕ -features (that is, person and/or number

⁶ It is interesting to note that although German had traditionally been analysed as a V-to-T language, a highly influential trend in the literature of the last decade argues that it is V-in situ (see Vikner 2005; Haider 2010; or also Biberauer and Roberts 2012). In the V2 structure (11) above *haben* 'have' is shown to raise to T, but as an intermediate position on its way to C.

features), τ -features (that is, features like [+/-present]), and a D-feature. I will now proceed to provide a brief description of each such account in consideration of space limitations.

As is widely known, Chomsky (2000, 2001) postulates an Agree relation between the uninterpretable ϕ -features of T and the interpretable ϕ -features on S, by means of which the agreement of the verb (that is, on v) is licensed, and nominative Case is licensed on S itself. Later, Pesetsky and Torrego (2004/2007) argue that the Case feature on DP cannot be considered just a by-product of the valuing of T's or v 's ϕ -features, and that Case must be identified as some uninterpretable feature on the DP itself. The authors thus propose that the Agree relation that applies between T, S, and v has at its centre the τ -features that are interpretable but unvalued on T, uninterpretable and unvalued on S, and uninterpretable and valued on v .

As for the third kind of feature mentioned above, namely a D-feature on T, this is the one Chomsky (2000, 2001) suggests to explain that not only a full lexical DP but also existential *there* can occupy Spec,T (*[There] are problems with the computers*), or also a locative PP (*[Between John and Mary] sat Elizabeth*), or otherwise a clause (*[That he should give up the job] is not possible / [For him to give up the job]...*).

T's D-feature, the trigger that I generally endorse in my research on the processing and linearisation of constituents in both head-initial and head-final sequences, would be unvalued and interpretable on T, and valued and uninterpretable on S itself. The relevant meaning or interpretation that corresponds to the D-feature, I would argue, is the *subject of predication*: thus S in SAuxVO or SVO would be identified as a subject of predication, and the remaining constituents –that is, AuxVO and VO, respectively– would act as *predicate*.⁷

The aim of the present section is to reject the possibility that any of the triggers that are typically associated with the raising of S(subject) into Spec,T can serve for the raising of the full v P into the cited Spec,T position. Thus, if S is argued to raise to T based on ϕ -features, there seems to be no logic at all in S attracting the v P to it, since ϕ -features cannot be related in any way to the v P as a whole, and the same applies to τ -features. Nor could it seem to be the case that each of the constituents inside v P could raise separately to Spec,T, as attracted by the cited ϕ -features or τ -features: with regard to v , this element has

⁷ For the sake of completeness, I would like to say that, in my research on processing and linearisation generally speaking, I endorse the view that T values its uninterpretable τ -features against v (as in Pesetsky and Torrego 2004/2007), and that T is involved in the licensing of ϕ -features on v (partially as in Chomsky 2000, 2001), though the cause of T's probing of S I argue to be a D-feature, as described in the main text.

already had its τ -features valued against T (in a head-final language like e.g. German, with no V-to-T), which means that τ -features cannot serve the relevant purpose, and with regard to a constituent like O, this cannot be considered the Goal of either τ -features or φ -features that could be valued in T.

The last option available would seem to be the D-feature trigger, which establishes S as *subject of predication*, and the rest of the clause as *predicate*, as described above in this section. However, if *v*P instead of S raises into Spec,T guided by the cited D-feature, then that should mean that *v*P passes on to realise the above-cited role of *subject of predication* in a head-final structure, and the finite verb (whether Aux or V in the corresponding SOVAux or SOV structure) should be *predicate*, a situation that seems illogical, since an SOVAux or SOV structure in a head-final language like German or Dutch expresses the same type of relation of predication as an SAuxVO or SVO structure in a head-initial language like English: namely, the relation between a subject (S) and a predicate (OVAux or OV).

4. THE PRESENT PROPOSAL: A SKETCH OF THE DERIVATION OF SOV/SOVAUX

From the issues discussed in sections 3.1 and 3.2 immediately above, I conclude that the mechanism of *v*P-pied piping is not appropriate to derive head-final structures. The present discussion is part of a wider work on head-initial vs. head-final configurations (as I noted in section 1), and the overall aim is to establish the precise number of Spell-Out units that make up both linear orders. Based upon the claim in (3) above, repeated once again below, I defend an account where S(ubject) is the first constituent to be processed and linearised (that is, sent to Spell-Out) in both head-initial and head-final configurations. My aim in this paper has been to show that the kind of movement that entails that the full *v*P raises to Spec, T, typically employed in LCA or Antisymmetry accounts of head-finality, happens to fail on various fronts.

- (3) Probe-goal search shares the directionality of parsing and of production
 →(=therefore)

Probe-goal search proceeds from left to right

(Kayne 2011: 12)

Another core idea of the overall proposal is that the head-final order OV –or also OVAux– is the result of a delay between the operation Agree and Spell-Out. In order to be able to establish the complete sequence of Spell-Out units, I still have work to do on the middle field in both head-initial and head-

final sequences from the perspective of (3), namely in regards to configurations where more than one object and/or adjuncts occur. Nevertheless, I can advance my claim here, in the last section of the paper, about the initial steps of a derivation containing just one O. In accord with my understanding of (3), S is processed and linearised in initial position in such a derivation and, consequently, vP -pied piping movement cannot be the case. Immediately afterwards, I will put an end to the section by suggesting the kind of analysis that can be used to derive head-final structures without recourse to vP -pied piping, nor for that matter to VP -pied piping. The analysis in question is a typical remnant movement as available in the general literature, plus an additional construct in the form of a twofold Spec position for T (in a similar fashion to the twofold Spec position for v generally assumed in the literature). In fact, the analysis was put forth for one of the sentence types in section 3.2 above, namely (12a'').

Now, the order of derivation that, as I would like to suggest, should abide by (3) is one like (13) below, where the Spell-Out of S(ubject) (13h) is the first Spell-Out operation to apply, once all other constituents in the clause or sentence have been merged. This kind of derivation is one where Merge goes bottom-up, as typically assumed in minimalist theory, but Agree goes top-down, in accordance with the c-command condition.⁸

- (13) a. Merge of V and O \rightarrow [_{VP} V O]
 b. Merge of v and VP \rightarrow [_{vP} v [_{VP} V O]]
 c. Merge of S and vP \rightarrow [_{vP} S v [_{VP} V O]]
 d. Internal Merge of V and v \rightarrow [_{vP} S v/V_h [_{VP} t_h O]]
 e. Merge of T and vP \rightarrow [_{TP} T [_{vP} S v [_{VP} V O]]]
 f. Merge of C and TP \rightarrow [_{CP} C [_{TP} T [_{vP} S [_{VP} V O]]]]
 g. Internal Merge of S and TP \rightarrow [_{CP} C [_{TP} S_i T [_{vP} t_i v [_{VP} V O]]]]
 h. Spell-Out of S
 ...

The idea is for (13h) to be followed by the linearisation of v/V , and this in turn by the linearisation of O in head-initial structures (see (14)), whereas the order would be reversed for head-final structures (see (15)).

⁸ As noted in section 1, this kind of derivation is an alternative to the claim in phase theory (Chomsky 2000 *et seq.*) that O constitutes the first Spell-Out unit. An analysis of the consequences of the approach in question belongs to work in preparation.

- (14) ...
- Spell-Out of *v/V*
- Spell-Out of O

- (15)...
- Spell-Out of O
- Spell-Out of *v/V*

As noted above, I do not complete the full process involved in (14)/(15) in this paper. However, I do specify below the types of movement that can explain the linearisation of O at the expense of the linearisation of *v/V* or, in other words, the movement that can explain the delay between Agree and Spell-Out of *v/V*. The following is therefore a brief sketch of the analysis that I propose for the head-final structures that have been mentioned in the paper. I follow the same order as in (7), and make use of the same informal notation. Immediately after (16) is a brief characterisation of each of the structural types.

- (16) a. SOV (with no V-to-T): movement of O to Spec,*v*

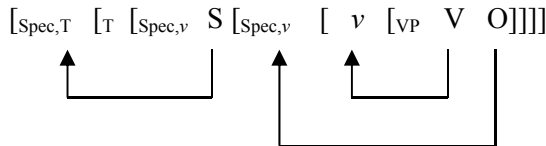

- b. S_O_V (with no V-to-T): movement of VP to Spec,*v*

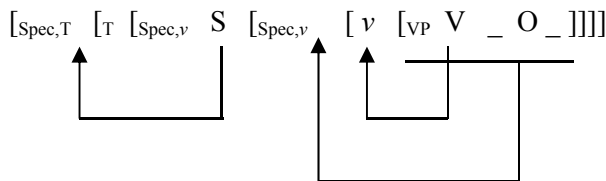

c. SOVAux: movement of vP to Spec,T

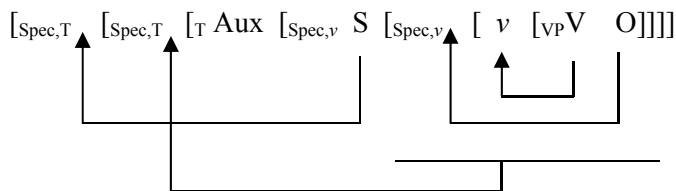

d. S_O_VAux: movement of VP to Spec,v and movement of vP to Spec,T

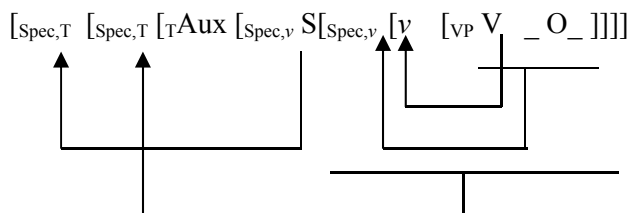

e. SOV (with V-to-T movement): movement of vP to Spec,T

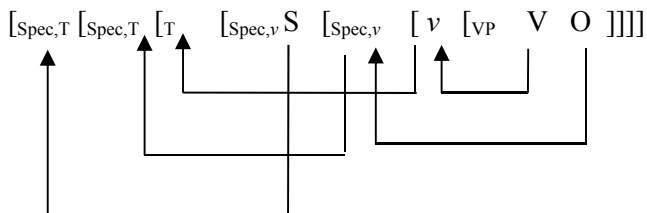

f. S_O_V (with V-to-T movement): movement of VP to Spec, v and movement of vP to Spec,T

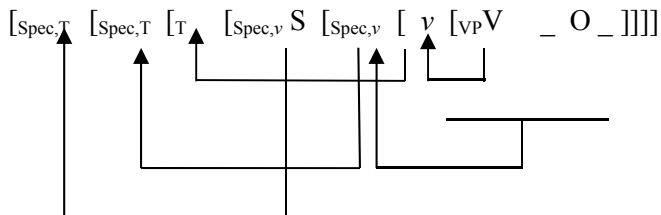

The trigger of movement is of course a core aspect in need of explanation. This way, Haegeman (2000) resorts to remnant movement in her account of head-final structures, but wonders about what could possibly be the cause.⁹ Jayaseelan (2010: 327) however, emphasises that the kinds of movement typically used in works that adopt Antisymmetry theory appear to have no other motivation but to vacate the VP, and wonders why languages would want to do this.¹⁰ I claim, in regards to the hypothesis I entertain in my work in preparation on the derivation of head-final structures from head-initial structures, that the order OV or otherwise OVAux is the result of an EPP feature of *v*, or of T or Aux, respectively. It is well known that resorting to an EPP feature of any given Probe is a device typically employed in minimalist theory. What I would like to highlight is that the justification of the EPP feature in my postulation would be just to obtain a head-final structure. That is, O would raise to the left of *v*, or OV would raise to the left of T or Aux, as guided by an EPP feature (of *v*, T, or Aux) whose goal it is to leave the verb in final position. This way, both head-initial and head-final languages would feature S(subject) in initial position, which constituent stands for subject of predication, and serves to mark the opening or beginning of the sentence, whereas only head-final languages would feature V (or Aux) in final position as a sign of sentence closure: the same as V marks the end of the sentence in SV sequences, so V (or Aux) would also mark the end of the sentence in SOV/SOVAux sequences. The speculation is that sequences whose predicate consists of just the verb would antedate from a historical perspective sequences whose predicate consists of one or more objects or complements in addition to the verb: a way of maintaining identity between sentences would therefore be to have the same constituent types –S and V, respectively– holding the two key positions that mark a sentence as such a linear sequence.

Starting then with structures that contain neither an auxiliary nor V-to-T movement, (16a) would be identical to (7a) above, but the movement of VP in (16b) would be just remnant movement of VP to Spec,*v* (since V has already moved to *v*) and not VP-pied piping movement. The reason for this is that, as described immediately above, the EPP feature of *v* would attract the full structure [_ O _], rather than O attracting with it the other constituents within VP.

⁹ I would like to highlight the fact that Haegeman (2000) does not discuss *v*P-pied piping, and further has S(subject) located in a safe position in Spec,AgrSP. Therefore she does not even need to consider a two-fold Spec position for T as I contend in the analysis that I advance below.

¹⁰ As will be recalled from section 2 above, Jayaseelan (2010) is one such work as contends that all languages in general are head-final, and that head-initial structures are the result of the verb raising to the left of the object due to morphological reasons.

Passing on to structures with an auxiliary located in T, as in (16c) and (16d), these differ crucially from (7c) and (7d) in that no ν P-pied piping would apply. That is, S(ubject) does not merge in Spec,T together with all the other constituents in ν P, but on its own. This entails acknowledging two Spec positions for T, as observed earlier in this Section: one for S(ubject) and the other for the rest of ν P, whether this is [OV], as in (16c), or [_ O_ V], as in (16d).

In (16c), remnant movement of ν P would apply, since S has already left the ν P itself. As already explained, the trigger for the raising of S would be T's D-feature, and the trigger for the raising of the remnant ν P would be an EPP feature of T (since Aux is in T in this structure). Incidentally, if Aux remains in AuxP, or in a ν P projection of its own, then the movement of the remnant ν P would be to the Spec of Aux (or otherwise of the higher ν P projection).

In (16d) remnant movement of VP applies to Spec, ν , since the portion [_ O_] moves without ν itself, and then applies remnant movement of ν P to Spec,T, since, for the same reason as in (16c), S has already merged in Spec,T: therefore ν P-pied piping is not the case.

As for SOV sequences and S_O_V sequences where V moves to T, the movement of ν P that is signalled in the former (that is, (16e)) is specifically remnant movement of ν P, since ν P raises to a second Spec position of T without S (which has already raised to the first Spec,T position) and without ν itself, since ν raises on this occasion to T. Regarding (16f), two kinds of remnant movement apply: on the one hand, remnant movement of VP to Spec, ν (since ν does not move with VP) and on the other hand, remnant movement of ν P to the second Spec position of T (since, just as in (16e) ν P raises without S and without ν itself).

Two of the configurations described above were chosen at random and represented as tree-diagrams. The one in (17a) is the Old English SOVAux sequence represented in (9) above as a ν P-pied piping structure, and that is now represented using remnant movement (see (16c)). The configuration in (17b) is a (subordinate) S_O_V sequence in German (see (16b)) and in that case the language is considered to be non-V-to-T. Both (17a) and (17b) would be more full-detailed versions of the movement operation hinted at in (5b) in section 2 of this paper.

(17) a. ...gif heo þæt bysmor forberan wolde
 if she that disgrace tolerate would

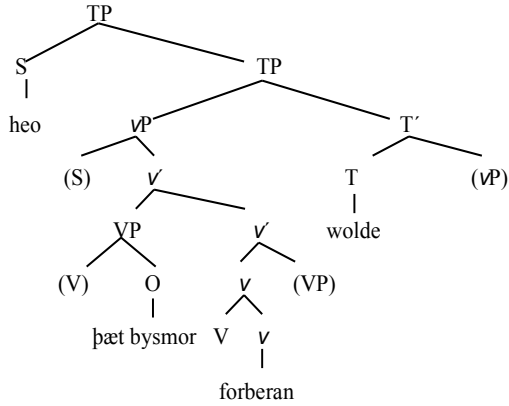

b. ...das die Studenten _ das Buch _ lasen
 that the students the book read

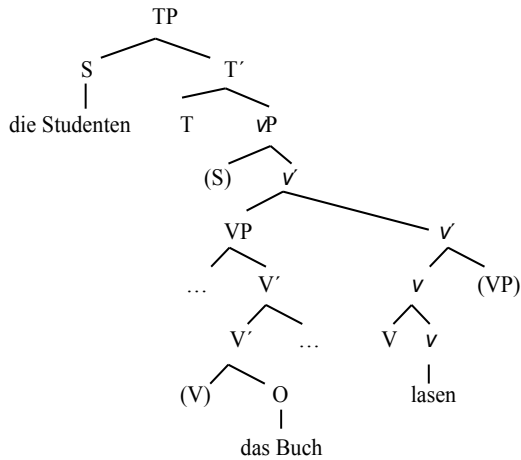

5. CONCLUSIONS

Though vP -pied piping is technically considered an impeccable type of roll-up movement in the general literature on deriving head-final structures from head-initial ones in accord with classical Antisymmetry precepts, there appears to be evidence that S(subject) does *not* move (or raise internally) into Spec,T together with the rest of the vP , but on its own. In this paper, two arguments have been raised against vP -pied piping: one based on floating quantifier structures and another on the trigger of the movement to Spec,T. On the one hand, I have argued that the quantifier is left stranded by its DP complement in a head-final language like German. On the other hand, I have attempted to show that none of the triggers proposed in various accounts in the literature on the internal merge of S in Spec, T –namely, ϕ -features, τ -features, or a D-feature– are valid for the internal merge of the full vP .

The more general hypothesis that I defend in my work in preparation is that a derivation that is in accordance not only with the classical postulates of Antisymmetry theory (Kayne 1994) but also with the claim in Kayne (2011/2013) that the order of production (that is, linearisation) goes the same way as the order of processing (that is, Agree) from left to right, is bound to be a derivation where S is the first constituent processed and immediately linearised and in which OV structures differ from VO structures. The difference will be in that in the former there is a delay between Agree and Spell-Out, whereas in the latter the delay is between Merge and Agree. In regards to the processing of S, I argue that the internal Merge or movement of this constituent into Spec,T is triggered by a D-feature that T must value, which could incidentally be counterpart to Case on S, and which would then be interpreted as subject of predication. For the Spell-Out of S to apply immediately after the Merge of all other constituents, but crucially before the Spell-Out of V and O, would mean that both head-initial and head-final languages typically feature S as such a subject of predication constituent, which does seem to be the case.

With regard to the above-cited Spell-Out of V and of O, I suggest in the last section of the paper that OV structures derive from VO structures through remnant movement of vP , or otherwise of VP, or even the more simple movement of O. However, relevant work is still pending on structures featuring more than one object and/or adjuncts before establishing this as a full explanatory account of head-finality. The remnant movement of vP entails the availability of two Spec positions for T, the same as the remnant movement of VP entails the same two Spec positions for v .

REFERENCES

- Abels, Klaus and Ad Neeleman. "Universal 20 without the LCA." *Merging Features: Computation, Interpretation and Acquisition*. Eds. Josep M. Brucart, Anna Gavarró, and Jaume Solà. Oxford: Oxford University Press, 2009: 60-79.
- Biberauer, Theresa and Ian Roberts. "Cascading Parameter Changes: Internally-driven Change in Middle and Early Modern English." *Grammatical Change and Linguistic Theory: The Rosendal Papers*. Ed. Thorhallur Eythórsson. Amsterdam: John Benjamins, 2008: 79-113.
- Cardinaletti, Anna and Giuliana Giusti. "Partitive *ne* and the QP-Hypothesis. A Case Study." Ms. University of Venice. 1989.
- Chomsky, Noam. "A Minimalist Program for Linguistic Theory." *The View from Building 20*. Ed. Ken Hale and Samuel J. Keyser. Cambridge, Mass.: MIT Press, 1993: 1-52.
- . *The Minimalist Program*. Cambridge, Mass.: MIT Press, 1995.
- . "Minimalist Inquiries: The Framework." *Step by Step: Essays on Minimalist Syntax in Honor of Howard Lasnik*. Eds. Roger Martin, David Michaels, and Juan Uriagereka. Cambridge, Mass.: MIT Press, 2000: 89-156.
- . "Derivation by Phase." *Ken Hale: A Life in Language*. Ed. Michael Kenstowicz. Cambridge, Mass.: MIT Press, 2001: 1-52.
- . "Beyond Explanatory Adequacy." *Structures and Beyond*. Ed. Adriana Belletti. New York: Oxford University Press, 2004: 104-131.
- . "Three Factors in the Language Design." *Linguistic Inquiry* 36 (2005): 1-22.
- . "On Phases." *Foundational Issues in Linguistics*. Eds. Carlos Otero, Robert Freidin, and Maria Luisa Zubizarreta. Cambridge, Mass.: MIT Press, 2008: 133-166.
- Haegeman, Liliane. "Remnant Movement and OV Order." *The Derivation of VO and OV*. Ed. Peter Svenonius. Amsterdam and Philadelphia: John Benjamins Publishing Company, 2000: 69-96.
- Haider, Hubner. *The Syntax of German*. Cambridge: Cambridge University Press, 2010.
- Hinterhölzl, Roland. *Restructuring Infinitives and the Theory of Complementation*. PhD dissertation, USC, 1999.
- Jayaseelan, K.A. "Stacking, Stranding, and Pied-Piping: A Proposal about Word Order." *Syntax* 13 (2010): 298-330.
- Kayne, Richard. *The Antisymmetry of Syntax*. Cambridge, Mass.: MIT Press, 1994.
- . "Overt vs. Covert Movement." *Syntax* 1 (1998): 128-191.
- . "Why Are There No Directionality Parameters?" *Proceedings of the 28th West Conference on Formal Linguistics*. Eds. Mary Byram Washburn et al. Somerville, Mass.: Cascadilla Proceeding Project, 2011/2013: 1-23.
- Kemenade, Ans van. *Syntactic Case and Morphological Case in the History of English*. Dordrecht: Foris, 1987.
- Pearson, Matthew. "Feature Inheritance and Remnant Movement: Deriving SOV Order Under the LCA." *Syntax at Sunset*. Ed. Gianluca Soto. Los Angeles: UCLA Department of Linguistics, 1999: 133-173.
- Pesetsky, David, and Esther Torrego. "The Syntax of Valuation and the Interpretability of Features." *Phrasal and Clausal Architecture: Syntactic Derivation and Interpretation. In Honor of Joseph E. Emonds*. Eds. Simin Karimi, Vida Samiian, and Wendy K. Wilkins. Amsterdam and Philadelphia: John Benjamins Publishing Company, 2004/2007: 262-294.
- Richards, Marc. "Desymmetrization: Parametric Variation at the PF-Interface." *The Canadian Journal of Linguistics* 53 (2008): 563-572.
- Roberts, Ian. *Diachronic Syntax*. Oxford: Oxford University Press, 2007.
- . "Head Movement and the Minimalist Program." *The Oxford Handbook of Linguistic Minimalism*. Ed. Cedric Boeckx. Oxford: Oxford University Press, 2011: 195-219.

- Sheehan, Michelle. "Explaining the Final-over-Final Constraint: Formal and Functional Approaches." *Theoretical Approaches to Disharmonic Word Order*. Eds. Theresa Biberauer and Michelle Sheehan. Oxford: Oxford University Press, 2013: 407-444.
- Shlonsky, Ur. "Quantifiers as Functional Heads: A Study of Quantifier Float in Hebrew." *Lingua* 84 (1991): 159-180.
- Sportiche, Dominique. "A Theory of Floating Quantifiers and Its Corollaries for Constituent Structure." *Linguistic Inquiry* 19 (1988): 425-449.
- Stowell, Timothy. *Origins of Phrase Structure*. PhD dissertation, MIT, 1981.
- Svenonius, Peter. "1...3-2." *Oxford Handbook of Linguistic Interfaces*. Eds. Gillian Ramchand and Charles Reiss. Oxford: Oxford University Press, 2007: 239-288.
- Taylor, Ann and Suan Pintzuk. "Verb Order, Object Position and Information Status in Old English." *York Papers in Linguistics Series 2* (2012): 29-52.
- Taraldsen, Knut Tarald. "V-movement and VP-movement in Derivations Leading to VO Order." *The Derivation of VO and OV*. Ed. Peter Svenonius. Amsterdam and Philadelphia: John Benjamins Publishing Company, 2000: 97-122.
- Travis, Lisa D. *Parameters and Effects of Word Order Variation*. PhD dissertation, MIT, 1984.
- Vikner, Sten. "Immobile Complex Verbs in Germanic." *Journal of Comparative Germanic Linguistics* 8 (2005): 83-115.
- Zwart, Jan-Wouter. "The Germanic SOV Languages and the Universal Base Hypothesis." *The New Comparative Syntax*. Ed. Liliane Haegeman. London: Longman, 1997: 246-267.