

Relationship between the degree of creativity and the quality of design outcomes

Elena Mulet ^a, Marta Royo^a, Vicente Chulvi^a & Julia Galán ^b

^a *Department of Mechanical Engineering and Construction. Universitat Jaume I, Castellón de la Plana, Spain. emulet@emc.uji.es, royo@emc.uji.es, chulvi@emc.uji.es*

^b *Department of Industrial Systems Engineering and Design., Universitat Jaume I, Castellón de la Plana, Spain. galan@esid.uji.es*

Received: October 15th, 2015. Received in revised form: July 5th, 2016. Accepted: September 27th, 2016.

Abstract

This work analyses the relationship between the degree of creativity, measured through the level of novelty and the level of usefulness, and the quality of the design outcomes. To do so, a total of twelve conceptual designs obtained in a design experiment were measured and compared. In this experiment, four teams of three designers solved different design problems, applying brainstorming, SCAMPER and functional analysis as design methods. The quality of the design solutions have been evaluated in terms of feasibility and effectiveness by experts through a questionnaire. Feasibility and effectiveness were then compared with the novelty, usefulness and creativity, the results showing that as novelty increases, feasibility tends to be lower, and the more usefulness the design offers, the more effective it is.

Keywords: creativity, idea generation, feasibility, design methods

Relación entre el grado de creatividad y la calidad de los resultados de diseño

Resumen

Este trabajo analiza la relación entre el grado de creatividad, medido a través del nivel de novedad y el nivel de utilidad, con la calidad de las soluciones del diseño. Para ello, un total de doce soluciones conceptuales obtenidas en un experimento de diseño han sido medidas y comparadas. En el experimento cuatro equipos de tres diseñadores cada uno, resolvieron distintos problemas de diseño aplicando el brainstorming, el SCAMPER y el análisis funcional como métodos de diseño. La calidad de las soluciones de diseño se ha evaluado por expertos en términos de factibilidad y efectividad usando un cuestionario. La factibilidad y la efectividad se comparado con la novedad, la utilidad y la creatividad, observando que cuando aumenta la novedad, la factibilidad tiende a reducirse y que, cuando mayor es la utilidad mayor es el grado de efectividad también.

Palabras clave: creatividad, generación de ideas, factibilidad, métodos de diseño.

1. Introduction

To generate new solutions to a product design problem it is usual to apply creativity methods that make it easy to explore and generate new solutions. The importance of creativity has been highlighted in many studies, and universities must promote good practices that foster these capabilities in order to create complete professionals [1]. Moreover, it is important to enhance it from childhood onwards [2].

The idea-generation process is essential to obtain creative

design solutions. Thus, there are several approaches to evaluate the effectiveness of the ideation process, such as that of Shah [3], who proposed four metrics: the novelty, variety, quality, and quantity of ideas generated. Here, quantity is defined as the degree to which an idea fulfils the design problem requirements.

The quality of the design solutions is related to different aspects, such as feasibility and effectiveness, and it is also linked to how productive the design process is. In the monograph edited by Duffy [4], the elements to measure design process productivity comprise the extent to which a solution

fulfils the design problem requirements and needs, the cost, the time or the technical requirements.

In this study, feasibility is considered to be the capability to implement a solution in practice, considering technological and cost criteria. Effectiveness is understood as the way in which the design solution provides an answer to the problem. Moreover, the term 'creativity' has been defined in different ways [5], all of them sharing the common notion that something is creative when it is novel and useful [6].

In a previous experiment, the degree of creativity of several design solutions obtained by applying different design methods was measured and compared. In this experiment, twelve designers were distributed in four teams of three members, one of them being a designer, another an engineer and the third one could be either a designer or an engineer. Four design problems were defined: a drawing table which occupied as little space as possible (P1), a tubular map case allowing for one-by-one extraction and introduction of maps (P2), a system to hide leads in tables (P3), and a table that allowed the user to work either seated or standing up (P4).

A criterion that is frequently used to classify design methods belongs to the intuitive methods, which allow the spontaneous generation of ideas and logical or structured methods, which in turn lead creative thinking to follow several steps in a more defined path. One of the best-known intuitive methods is brainstorming and all its variants. This method consists in the spontaneous generation of as many ideas as possible in a team, avoiding any kind of judgement or criticism [7]. Among the structured methods, functional analysis [8] analyses the functions in a new design and their relationships in order to search for potential solutions. The SCAMPER method is a lateral thinking technique that promotes the generation of ideas based on a list of questions that ask, among other things, which design elements can be substituted, adapted or used in a different way [9].

This experiment was organised in such a way that each team had to solve one of the design problems without applying any prescribed method (no method) and then they solved two other design problems by applying different design methods, namely two types of brainstorming (BR1) and (BR2), and the SCAMPER and functional analysis methods, as shown in Table 1. As can be seen, each of the four methods (BR1, BR2, functional analysis and Scamper) were applied by two different teams in two different design problems during the experiment.

Table 1.
Design experiment

Team	Session 1	Session 2	Session 3
Team 1	No method (NM) Problem 4	Brainstorming version 1 (BR1) Problem 2	SCAMPER Problem 1
Team 2	No method (NM) Problem 3	Brainstorming version 1 (BR1) Problem 1	SCAMPER Problem 2
Team 3	No method (NM) Problem 1	Brainstorming version 2 (BR2) Problem 3	Functional analysis (FA) Problem 4
Team 4	No method (NM) Problem 2	Brainstorming version 2 (BR2) Problem 4	Functional analysis (FA) Problem 3

Source: Own elaboration

Once the experiment had ended, the degree of creativity was measured by means of the degree of novelty and usefulness of the solutions in two different ways: by applying the SAPPhIRE model, and through experts' opinion. The SAPPhIRE model, which stands for State-Action-Part-Phenomenon-Input-oRgan-Effect [10], is used to assess the relative degree of novelty depending on the level on which the change is identified in the causality model that describes the product functionality at different levels of abstraction. Usefulness is obtained by means of a mathematical formula using the importance of the product, the usage frequency, the duration of the benefit and the popularity ratio as input variables. With this measuring method, the different solutions obtained for a design problem were classified according to their novelty, usefulness and creativity. The most novel and useful solution was scored with a 1, the second with a 2 and so on. Lastly, creativity was measured as the product between the other two metrics: novelty and usefulness [11,12].

The degree of creativity of the results of the experiment, measured with Sarkar and Chakrabarti's method, showed that brainstorming stimulates more novel solutions and that the method that generates more useful solutions is functional analysis, which can probably be due to the fact that this method leads human thinking towards the functionality of the solution [13].

One of the disadvantages of evaluating a solution after a creative process, and more so if the study is conducted in an academic context, is the difficulty involved in valuing the technical and economic feasibility of the solution, since this is defined at a very conceptual level and there is no specific information about the manufacturing technologies and materials.

Thus, the quality of the conceptual solutions generated in the experiment were evaluated by means of an opinion questionnaire answered by eight external experts with professional experience in the design of furniture or similar products. Nonetheless, only seven of them were considered for the analysis, since one of them presented a deviation higher than 3 sigma. The results show that experts also rated the solutions generated when functional analysis was applied as the most feasible. Solutions generated with SCAMPER and no method were less feasible, and even less so with brainstorming. When no design method was prescribed, the feasibility was lower than with functional analysis [14]. Experts also rated the solutions generated using functional analysis as more effective, followed by those obtained when SCAMPER, no method and brainstorming were applied (Fig. 1). The differences were lower than for feasibility, that is, the design method had a lower influence on effectiveness than on feasibility. Again, functional analysis was the best one, probably because it enables the designer to focus his/her mind on searching for design solutions that solve the design problem.

Several studies have carried out experimental analyses of creative stimuli and methods in the effectiveness of the creative design process [15], [16] and [17]. For example, in López-Mesa et al. [18], the feasibility of the ideas generated was studied under the hypothesis that the more time devoted to developing an idea during the design process, the higher feasibility will be. This analysis was performed by comparing the time devoted to ideas when visual stimuli were used and when the SCAMPER questions were used as stimuli. The results showed that SCAMPER led to the generation of more feasible ideas than when images were used as external stimuli in a brainstorming method.

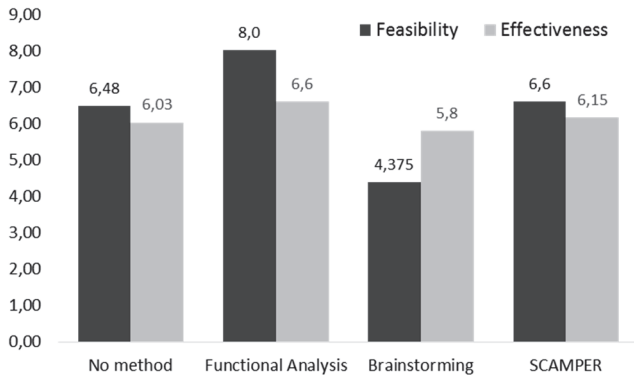

Figure 1. Mean feasibility and effectiveness in the design solutions for the different design methods
Source: Own elaboration.

The appropriateness of brainstorming as a method to obtain more novel ideas has also been analysed in a study [19] which compared the design results obtained using TRIZ and those obtained using SCAMPER, it was observed that the design solution generated by a team that used brainstorming showed the most novel value, but its usefulness was negative.

These analyses provide information that helps in the selection of the most appropriate method during the creative phase of the design process. Considering that obtaining very creative ideas is linked with ideas that are difficult to implement in practice, but, at the same time, it is very important to promote creativity within the innovation process, it would be interesting to analyse the possible relation between the degree of novelty of the design solutions and their quality.

Is it true that the more creative ideas are less feasible and less effective? And, conversely, when the solutions generated are less creative, are they more feasible and better fulfil the objectives and requirements of the problem? The objective of

this study is to analyse the relationship between feasibility and effectiveness and the degree of novelty, usefulness and creativity of the design outcomes.

2. Methodology

The design outcomes generated during the experiment are depicted in Table 2, and consist of three different solutions for each design problem, each one generated by a different design team and using a different design method. All the teams were asked to draw and describe the final solution decided on by the team using pencils and paper, although one team built up a paper mock-up for one of the solutions. The first row in Table 2 shows the results for the drawing table (P1), the second one the outcomes for the tubular map case (P2), the third row contains the solutions of three design teams for the system to hide leads in tables (P3) and the last row shows the design outcomes for the table to work seated and standing up (P4). Therefore, there are three different design outcomes for each of the design problems proposed.

Table 3 shows the questionnaire answers about the degree of feasibility and effectiveness according to the experts' opinion [14], using a scale of 1 to 10 (where 10 is the highest and 1 the lowest). The values for the degree of novelty, usefulness and creativity employed in this study have been obtained in two ways, as described in detail in [13], in which a normalised scale between 0 and 1 was employed. In Table 3, a scale of 1 to 3, instead of a normalised one, was used, where 1 is the most novel, useful and creative and 3 the least. The two ways to assess it are:

- The experts' criteria, by means of a questionnaire.
- Creativity method defined by Sarkar and Chakrabarti [12].

Table 2.
Design outcomes obtained by each design team, for the four design problems using different design methods

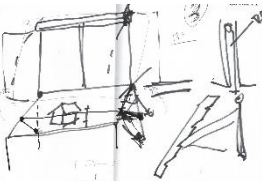
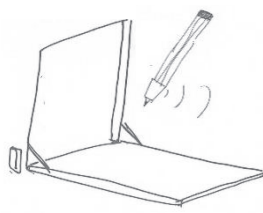
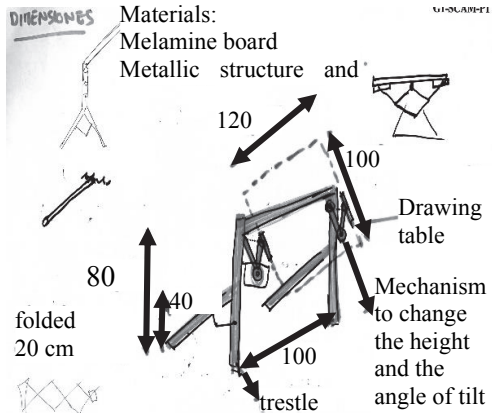
No method	Brainstorming	SCAMPER
<p>Foldable table, using hinges</p> 	<p>It uses a digital pencil. The table consists of a board embedded in the wall that can be open out to use it. The digital pencil is placed on a standard pencil and it transforms the pencil movements into infra-red signals that are sent to a computer. To be open out from the wall two belts are used.</p> 	<p>Structure: trestle system to reduce the space. The height and the angle of tilt can be controlled. Easy to fold up and store. It can also be use also as a blackboard</p> <p>Materials: Melamine board Metallic structure and</p> 

Concentric tubes

To introduce a map:

- Select a single tube.
- Extract the tube
- Roll the map and ensure it
- Insert the map
- Close the screw top

To extract a map:

- Select a single tube
- Extract the tube
- Unroll the map

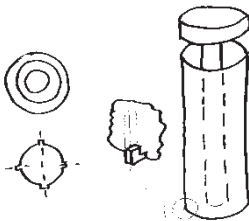

Binder-like system. Every map is separated from the others and can be easily extracted.

To protect the maps, the binder system can be rolled and introduced in a tube.

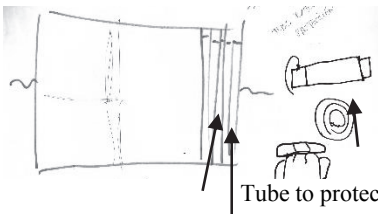

Sheets to put every map in one

Paperclips to hold the maps separated and in concentric positions

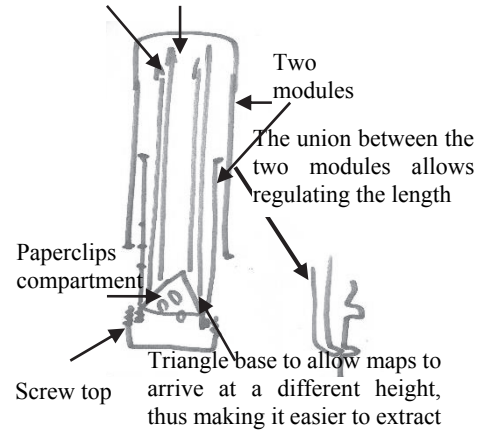

The wires are tight by velcro on the inferior face of the table and are lead to the leg. There is a plug in the leg to connect the wires

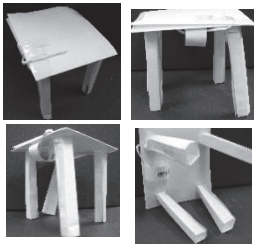

A plug is available in the table next to the legs, to connect all the elements in it.

For the other signals, wireless communication will be used

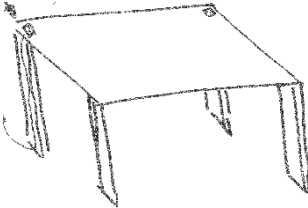

A channel to place in the lateral or inferior surface of the table

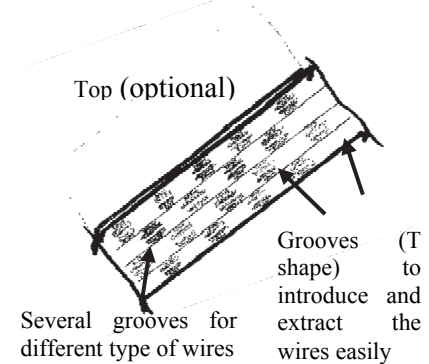

No method

A metallic structure holds the table to the wall. It allows changing easily the height and the angle of tilt.

It can be used for different purposes

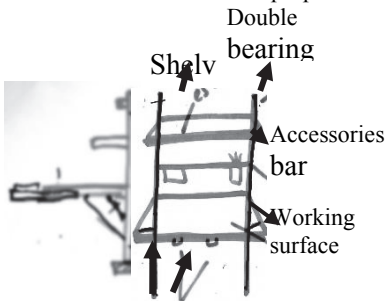

Handles to ease the movement

Brainstorming

Virtual table

A virtual screen with an optical pencil to manipulate it.

It does not provide a physical support; the arms are not supported.

It can be manipulated as a holographic system.

You could write, erase, etc., in a virtual way.

The table could be used in all the positions: to work sitting down, standing up, in different angles of tilt, etc.

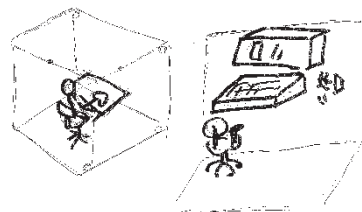

Functional analysis

There are no sketches for this solution. The proposed components and their respective functions:

- **Bearing** (to enlarge the board surface)
- **Wheels** (to move)
- **Hydraulic system** (to stand up the board, to change its position)
- **Two legs** (to support)
- **Rack**. (to keep pencils and objects in the board, avoiding these to fall down)

Source: Reference [13]

Table 3.

Mean feasibility and effectiveness, and order of novelty, usefulness and creativity according to experts and to Sarkar and Chakrabarti.

Experiment case	Experts opinion (from 1 to 10)		Experts opinion (1 the best, 3 the worst)			Sarkar and Chakrabarti's metric (1 the best, 3 the worst)		
	Feasibility	Effectiveness	Novelty	Usefulness	Creativity	Novelty	Usefulness	Creativity
G1-SCAMP-P1	7.6	7.0	2.50	1.88	2.00	3.00	3.00	3.00
G2-BR-P1	2.9	5.6	1.38	2.38	2.00	1.00	1.00	1.00
G3-NM-P1	7.5	7.4	2.13	1.75	2.00	2.00	2.00	2.00
G2-SCAMP-P2	5.6	5.3	2.13	2.50	2.00	2.00	3.00	2.00
G1-BR-P2	8.50	6.9	2.25	1.50	2.25	1.00	1.00	1.00
G4-NM-P2	5.3	6.7	1.63	2.00	1.75	3.00	2.00	2.00
G4-FA-P3	8.2	6.4	1.88	1.63	2.00	1.00	1.00	1.00
G3-BR-P3	4.4	7.50	1.50	1.88	1.63	2.00	2.00	2.00
G2-NM-P3	5.3	2.8	2.63	2.50	2.38	2.00	3.00	3.00
G4-BR-P4	1.7	3.2	1.00	3.00	1.50	1.00	3.00	2.00
G3-FA-P4	7.8	6.8	2.50	1.50	2.00	3.00	2.00	3.00
G1-NM-P4	7.8	7.2	2.50	1.50	2.50	2.00	1.00	1.00

Source: Own elaboration.

To study the potential relation between feasibility and effectiveness with the parameters that define creativity (novelty and usefulness), scatter diagrams were plotted for each of the pairs to be compared: feasibility-novelty, effectiveness-novelty, feasibility-usefulness, effectiveness-usefulness, feasibility-creativity and effectiveness-creativity. Several regression models were applied to the scatter diagrams in order to identify potential relationships, and the regression curves for the data are depicted.

3. Results

The following figure represents each of the design outcomes obtained in the experiment in such a way that the position on the y-axis is the order in the degree of novelty and its x-axis position is the feasibility score (Fig. 2a) and the effectiveness score (Fig. 2b). Both the degree of novelty according to the experts' opinion and to the SAPPPhIRE method are represented.

No significant fit is found, since none of the R2 values are high enough to consider the fit as significant. In any case, a tendency is observed in some cases. As can be seen, novelty, as measured by the experts, decreases when the feasibility increases, that is, the more novel the solution is, the less feasible it seems to be. The curve in Fig. 2a represents the potential regression tendency of the data. When novelty is assessed with the SAPPPhIRE method, there is one outcome with high feasibility that is also very novel, and, consequently, even though there also seems to be a relationship, it is less clear than when novelty was evaluated by the experts.

This could be due to the fact that the most novel outcomes usually involve complex or novel technologies, which are still under development or it is the result of not taking into account all the needs of the problem. This is what has happened, for instance, with the virtual table that uses holographic systems.

Fig. 2b shows that there is no relation between the degree of effectiveness and novelty, since there are very novel solutions that are very effective and very novel solutions that have low effectiveness, in both the experts' criteria and the SAPPPhIRE method. That is, the designers generate design solutions whose degree of novelty appears to be unrelated to how well the solution solves the design problem.

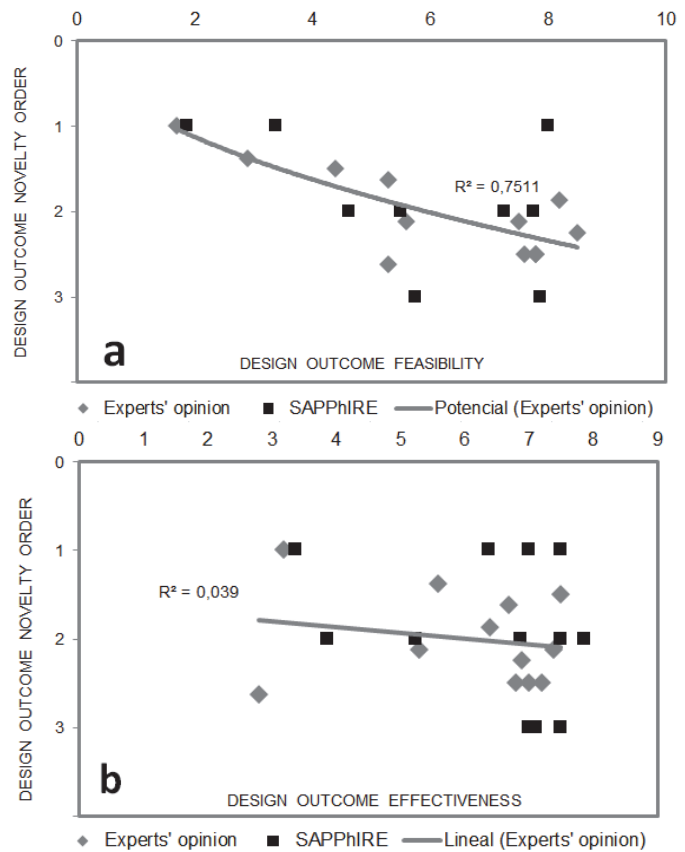

Figure 2. Relationship between the degree of novelty and a) feasibility, and b) effectiveness

Source: Own elaboration.

Regarding the degree of utility of the solution, Fig. 3a shows that there is no relation between this and the degree of feasibility, since the dots that represent the design outcome scores on usefulness and feasibility are highly dispersed in the scatter plot. In other words, during the creative ideation of ideas, when designers still do not have to think about technical details, the design process does not lead to a different level of feasibility depending on the usefulness parameters, which take into account the duration and frequency of usage.

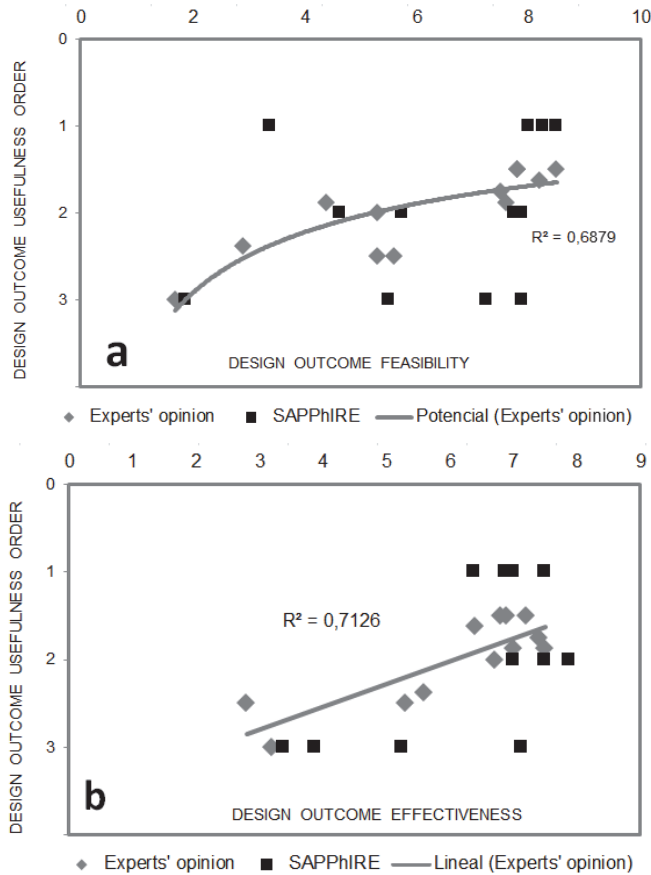

Figure 3. Relationship between usefulness and a) feasibility, and b) effectiveness
Source: Own elaboration.

Fig. 3b shows a possible relationship between effectiveness and usefulness in such a way that the more effective the design outcome is, the more useful it is in both the experts' opinion and the SAPPhIRE method. Hence, when the design method produces more effective outcomes, they are also more useful. This relationship is stronger when the usefulness is evaluated by the experts, maybe because in their own criteria, usefulness is very similar to effectiveness.

The relationship between usefulness and effectiveness might not be so direct in other kinds of design problems to those analysed in this study. One example of this could be if the design requirements do not consider generating solutions that improve the usage of the products, as could happen in a design problem concerning an anecdotal need.

Lastly, the scatter plots of the degree of creativity are depicted in Fig. 4. The first observation is that the solutions obtained present more similarities in the degree of creativity than in novelty and usefulness, since all the dots are closer to each other on the y-axis. Moreover, there is no relationship between creativity and feasibility or between creativity and effectiveness. Since creativity comprises both novelty and usefulness [5], the reason why there not many differences may be that there are very novel solutions with a low degree of usefulness and vice versa. It is more difficult to generate solutions with high novelty and at the same time high usefulness, and that is why creativity values are lower.

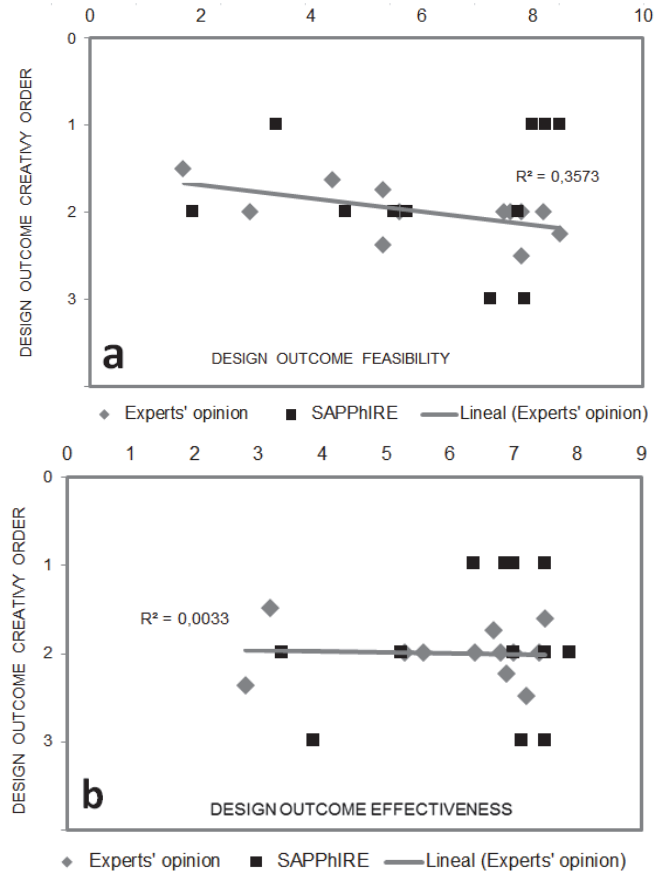

Figure 4. Relationship between the degree of creativity and a) feasibility, and b) effectiveness
Source: Own elaboration.

So, assuming that to generate creative solutions they need to be both novel and useful, it has to be taken into account that when the design outcomes are more novel, the feasibility tends to be lower. If design methods like brainstorming and SCAMPER are used to generate creative solutions, it is advisable to conduct a feasibility analysis and, if needed, research new ideas to increase the feasibility. These methods usually lead to highly creative ideas [13] and so they are appropriate even though they can lead to low feasibility.

In future research it could be interesting to analyse the extent to which the expressive ability to draw and describe the design outcomes might have affected the evaluators' perception and, consequently, their final scores.

4. Conclusions

This study analyses the relationship between feasibility and effectiveness and the values for novelty, usefulness and creativity. The results show that the higher the degree of novelty is, the lower the feasibility of the design outcomes will be. Hence, when designers are generating creative ideas, it is recommended that a review of the feasibility should be conducted in those design outcomes that present a high level of novelty. Failing that, the design objectives should be redefined, since it is also common that creative ideas imply

complex or emergent technologies, which are difficult to implement in practice. This is what has happened in design outcomes like the one in which a holographic system was proposed.

Moreover, there seems to be a relation between the degree of effectiveness of the design outcome and the degree of usefulness. Consequently, a good level of resolution of the design problem seems to be related to solutions that can be used more, at least in the design problems employed in this study. This is the case of the outcomes generated with functional analysis, which present a higher score on usefulness and also on effectiveness.

Thus, since when the feasibility increases, novelty is lower and usefulness remains similar, creativity, as the combination of novelty and usefulness, should decrease. Looking at Fig. 4a it can be seen that, with the collected data, this relationship has a very low correlation and consequently it cannot be assessed, although there is a gentle trend to decrease creativity when feasibility increases. This trend is stronger in the experts' evaluation than in the SAPPPhIRE method.

Likewise, since when effectiveness increases, usefulness is higher and novelty remains the same, creativity should increase. However, with the data collected in this experiment, no relationship can be determined, since the data are very dispersed (Fig. 4b).

These conclusions agree with previous studies, such as Chulvi et al. [19], in which brainstorming led to higher novelty, but usefulness was low. The present study has allowed us to confirm this pattern in a larger number of cases, since the design outcomes are more novel but less useful when the brainstorming method is applied.

Acknowledgements

This study has been possible thanks to the research projects P1·1B2010-51 "Estimulación y evaluación de la creatividad en el diseño de productos en equipos de diseño distribuidos" and P11A2008-04 "Determinación de la influencia de métodos creativos en el proceso de diseño y del grado de novedad y utilidad de las soluciones", funded by the Universitat Jaume I. The authors also wish to acknowledge the help of Sara Romero, Águeda Sonseca and all the participants in the experiment.

References

- [1] Aizpun, M., Sandino, D. and Merideno, I., Developing students' aptitudes through University-Industry collaboration. *Ingeniería e Investigación*, 35(3), pp. 121-128, 2015. DOI: 10.15446/ing.investig.v35n3.48188
- [2] Soler, L.C.T., Un camino al éxito: la creatividad. *Ingeniería e Investigación*, (50), pp. 82-89, 2002. DOI: 10.15446/ing.investig
- [3] Shah, J. and Vargas-Hernandez, N., Metrics for measuril2d1 +ng ideation effectiveness. *Design Studies*, 24 pp. 111-143, 2003. DOI: 10.1016/S0142-694X(02)00034-0
- [4] Duffy, A.H.B., *The design productivity debate*. Springer-Verlag. London limited, 1998. ISBN: 978-1-4471-1540-3
- [5] Sarkar, P. and Chakrabarti, A., Assessing design creativity, *Design Studies*, 32(4), pp. 348-383, 2011. DOI: 10.1016/j.destud.2011.01.002
- [6] Boden, M.A., Computer models of creativity. In J. Sternberg (Ed.), *Handbook of creativity*, Cambridge University Press, Cambridge, 1999.
- [7] Osborn, A.F., *Applied imagination: Principles and procedures of creative problem-solving*. New York: Scribner. 1953. ASIN: B000PRMBB4
- [8] Jones, J., *Design methods: Seeds of human futures*. Wiley-Interscience New York, 1970. ISBN: 0-471-28496-3
- [9] Vehar, J., Miller, B. and Firestien, R., *Creativity unbound. An introduction to creative problem solving* (Innovation Systems Group), 1999.
- [10] Chakrabarti, A., Sarkar, P., Leelavathamma, B. and Nataraju, B.S., A functional representation for aiding biomimetic and artificial inspiration of new ideas. *Artificial intelligence for engineering design, analysis and manufacturing (AIEDAM)*, 19, pp. 113-132, 2005. DOI: 10.1017/S0890060405050109
- [11] Sarkar, P. and Chakrabarti, A., Development of a method for assessing design creativity. In: *Proceedings of the 16th International Conference on Engineering Design (ICED07)*, Paris, France, 2007.
- [12] Sarkar, P. and Chakrabarti, A., Studying engineering design creativity- developing a common definition and associated measures. In *Studying Design Creativity*, (ed. J Gero), Springer Verlag, 2008.
- [13] Chulvi, V., Mulet, E., Chakrabarti, A., López-Mesa, B. and González-Cruz, M.C., Comparison of the degree of creativity in the design outcomes using different design methods. *Journal of Engineering Design*, 23(4), pp. 241-269, 2012. DOI: 10.1080/09544828.2011.624501
- [14] Mulet, E., Chulvi, V., Sonseca, A. and Lopez-Mesa, B., Comparación del grado de efectividad y de factibilidad de la solución en distintos métodos de diseño. *XIV International Congress on Project Engineering*. Madrid. AEIPRO, 2010. ISBN: 978-84-614-2608-9
- [15] Weaver, J.M., Kuhr, R., Wang, D., Crawford, R.H., Wood, K.L., Jensen, D. and Linsey, J.S., Increasing innovation in multi-function systems: evaluation and experimentation of two ideation methods for design. *InASME 2009 International Design Engineering Technical Conferences and Computers and Information in Engineering Conference*, pp. 965-983. American Society of Mechanical Engineers, 2009.
- [16] Gonçalves, M., Cardoso, C. and Badke-Schaub, P., What inspires designers? Preferences on inspirational approaches during idea generation, *Design Studies*, 35(1), pp. 29-53, 2014. ISSN 0142-694X DOI: 10.1016/j.destud.2013.09.001
- [17] Mulet, E., Análisis experimental y modelización descriptiva del proceso de diseño. PhD Thesis. Projects Engineering department. Technical University of Valencia. Spain, 2003.
- [18] López-Mesa, B., Mulet, E., Thompson, G. and Vidal, R., Effects of additional stimuli on idea-finding in design teams. *Journal of Engineering Design*, 22(1), pp. 31-54, 2011. DOI: 10.1080/09544820902911366
- [19] Chulvi, V., González-Cruz, M.C., Mulet, E. and Aguilar-Zambrano, J., Influence of the type of idea-generation method on the creativity of solutions. *Research in Engineering Design*, 24(1), pp.33-41, 2013. DOI: 10.1007/s00163-012-0134-0

E. Mulet received her BSc. in Industrial Engineering in 2000 at the Universitat Jaume I and a PhD degree in Engineering Projects and Innovation in 2003 at the Universitat Politècnica de València, Spain. She teaches in several bachelor's and master's degrees, mainly in the Bachelor in Engineering in Industrial Design and Product Development. Her research focuses on design methods and creativity during the design process, an area in which she has published in journals such as *Research in Engineering Design* or *Journal of Engineering Design*, among others. She has also researched in sustainable design. She has submitted several communications at international conferences and she is or has been part of the scientific committee of conferences such as ICED, DESIGN, ICoRD, ICDC or Design Computing and Cognition. She has co-supervised two doctoral theses and is a member of the scientific committee of the *International Journal of Design Creativity and Innovation*.
ORCID: 0000-0003-4903-1273

M. Royo, received her BSc. in Industrial Design Engineering at the Universitat Jaume I de Castellón in 1997, and a MSc. in Secondary Education, vocational training and language teaching (2013) and a MSc. in Design and Manufacturing (2014) at the same university. For over eleven years she has combined her work as a professional industrial designer in several furniture companies with her teaching career. She has also been teaching at the Universitat Jaume I since 2004. Moreover, she is a teacher in formative workshops about creativity, design and web design. Her doctoral thesis focused on design methods and user emotions -*/and she has also researched into creativity in design education. In June 2016 she received her PhD degree in Industrial Technologies and Materials. She has already published several communications in conferences such as the ICED or the international Congress on Project Management and Engineering.
ORCID: 0000-0003- 2966-9093

V. Chulvi, received his BSc in Mechanical Engineering at the Universitat Politècnica de València in 2001. He developed his professional career in the automotive sector until 2004, in combination with his studies in the MSc. in Occupational Risk Prevention (2003) at the Universitat Jaume I. Later, he received a degree in industrial engineering (2007) and a PhD in an inter-university PhD programme about technological innovation projects in product and process engineering (2010). From 2005 to 2008 he obtained several research grants at the Universitat Jaume I, including an FPI grant. In 2008 he obtained a position as an assistant lecturer at this University. He has already published 12 papers in indexed research journals and more than 30 communications at scientific conferences.
ORCID: 0000-0002- 0708-3852

J. Galán, received her BA in Art Studies in 1987 and her PhD degree in Arts in 1991 at the Universitat Politècnica de València, Spain. She is the head of the Bachelor in Engineering in Industrial Design and Product Development, a degree course in which she teaches. She has been the head of the DACTIC research group since its foundation. Her research activity is focused on artwork applying new technologies to art. She has published numerous books about the most influential concepts that act as creative mechanisms in art and design nowadays, studying the mutual influences between these and the most innovative trends. She has also published several papers in scientific journals and a large number of communications at international conferences.
ORCID: 0000-0002-6075-0802



UNIVERSIDAD NACIONAL DE COLOMBIA

SEDE MEDELLÍN
FACULTAD DE MINAS

Área Curricular de Ingeniería Administrativa e
Ingeniería Industrial

Oferta de Posgrados

Especialización en Gestión Empresarial
Especialización en Ingeniería Financiera
Maestría en Ingeniería Administrativa
Maestría en Ingeniería Industrial
Doctorado en Ingeniería - Industria y Organizaciones

Mayor información:

E-mail: acia_med@unal.edu.co
Teléfono: (57-4) 425 52 02