

STUDY OF A HOT ASPHALT MIXTURE RESPONSE BASED ON ENERGY CONCEPTS

ESTUDIO DEL COMPORTAMIENTO DE UNA MEZCLA ASFÁLTICA A PARTIR DE CONCEPTOS DE ENERGÍA

OSCAR JAVIER REYES-ORTIZ

Associate Professor at the Nueva Granada Military University. Colombia. oscar.reyes@unimilitar.edu.co

ALEX E. ALVAREZ-LUGO

Assistant Professor at the University of Magdalena. Colombia. alexalvarez@yahoo.com

RAMÓN BOTELLA-NIETO

Doctoral student at the Polytechnic University of Catalonia. Ramón.botella@upc.es

Received for review September 3rd, 2010; accepted March 14th, 2011; final version April 4th, 2011

ABSTRACT: The main objective of the research reported in this paper is to determine the response of a hot mix asphalt (HMA) in terms of both the tensile strength and energy parameters (based on the assessment of the force-displacement curve) as potential tools for improving the HMA mixture design. The HMAs analyzed were fabricated using a 60-70 penetration asphalt binder, dense-graded aggregate, mineral filler, and different types and contents of mineral filler replacements (i.e., lime, cement, and fly ash). The indirect tensile test was conducted to determine both the HMA tensile strength and force-displacement curve, which allowed for the computation of the HMA toughness as well as the energies involved in the process before and after reaching the tensile strength. Corresponding results suggest that the replacement of mineral filler by cement, lime, and fly ash modified the HMA response in terms of both the tensile strength and energy parameters. In addition, analysis of the energy parameters discussed proved to be useful for determining the optimum mineral filler content of HMA. Consequently, analysis of these energy parameters can benefit the HMA mixture design process.

KEY WORDS: Toughness, hot mix asphalt (HMA), indirect tensile test, tensile strength, mineral filler, mixture design

RESUMEN: El objetivo principal de la investigación fue determinar el comportamiento de una mezcla asfáltica en función de la resistencia a la tracción indirecta y parámetros de energía (calculados en función de la curva fuerza-desplazamiento) como herramientas potenciales para mejorar el diseño de mezclas asfálticas. Las mezclas asfálticas analizadas fueron fabricadas con asfalto de penetración 60/70, granulometría cerrada md10 y relleno mineral en diferentes porcentajes y materiales (cal, cemento y ceniza volante). El ensayo de tracción indirecta se utilizó para determinar la resistencia máxima a la tracción y la curva fuerza-desplazamiento, a partir de la cual se calcularon la tenacidad de la mezcla y las energías involucradas en el proceso antes y después de alcanzar la resistencia máxima. Los resultados obtenidos sugieren que reemplazar el relleno mineral por cemento, cal o ceniza volante modifica el comportamiento de la mezcla asfáltica en términos de la resistencia a la tracción y los parámetros de energía. Adicionalmente, el análisis de los parámetros de energía discutidos es útil para establecer el contenido óptimo del relleno mineral. En consecuencia, el análisis de estos parámetros de energía puede beneficiar el proceso de diseño de mezclas asfálticas.

PALABRAS CLAVE: Tenacidad, mezcla asfáltica en caliente, ensayo de tracción indirecta, resistencia a la tracción indirecta, relleno mineral, diseño de mezcla

1. INTRODUCTION

Flexible pavements are structures designed using mathematical models of response and performance as well as laboratory testing to assess material properties and the response of those materials used to construct the structure. In addition, a comparison of laboratory testing results and technical specifications is required to ensure proper material and structural performance.

The tensile strength of the hot mix asphalt (HMA) constitutes one of the main mechanical parameters evaluated in the laboratory. The tensile strength can be measured using the indirect tensile test (ITT), also called the *Brazilian test* [1]. In the ITT, a cylindrical HMA specimen is subjected to static, or repeated, compressive load applied along the vertical diametral plane. Based on the conditions of load and the specimen geometry, a computation of the tensile strength, displacement, and stiffness of the HMA is possible [2].

Figure 1 shows the ITT stress distribution, indicating the principal (horizontal and vertical) planes. The vertical stress distribution is variable (Figure 1a), while the distribution of the horizontal stress is mostly uniform along the plane (Figure 1b) [3].

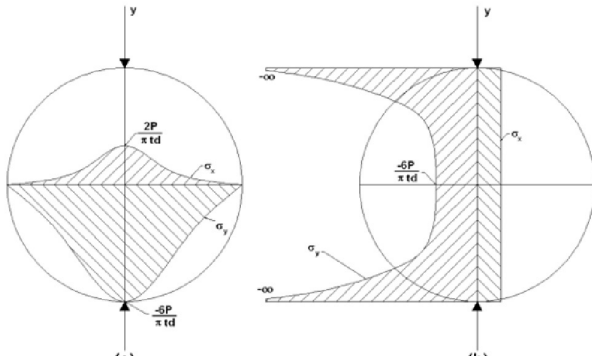

Figure 1. ITT theoretical stress distribution on the diametral (a) and vertical (b) planes [4]

One of the main characteristics of the HMA is its capacity to deform, while taking high cyclic stress levels, without fracturing. The HMA shear strength response includes both friction (based on aggregate particles interaction) and cohesion (related to the role of the asphalt binder-mineral filler—also called *mastic*—). However, computation of each of these components, based on the ITT, is cumbersome.

A few years ago, the HMA elastic response was computed in terms of load, displacement, strength, and stiffness. However, recent technological advances allowed using energy concepts to further analyze the mixture response. In fact, any simple event on a material supposes a transformation of different forms of energy. The total energy under the force-displacement curve is termed *toughness* (Figure 2). This energy or capacity to conduct work is equivalent to the product of force and displacement. Thus, in the IS, the energy is expressed in joules [5].

The capacity of a material to store strain energy and to withstand elastic deformations without breaking is called *resilience*. In other words, resilience can be defined as the amount of strain energy that a material can store without permanent damage, although the strain energy is partially used to propagate cracks in a tensile test. At intermediate service temperatures (e.g., 25 °C), HMA mixtures with high resilience values are preferred.

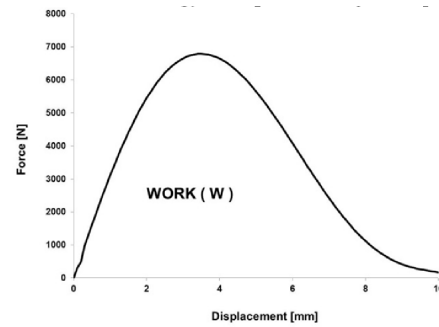

Figure 2. Typical force-displacement response for HMA under the ITT

On the other hand, according to the theory of plasticity, the response of ideal solids can be described in terms of two mechanical conditions: initial elastic and elastoplastic [6, 7, 8, 9]. In the initial elastic condition, stress is a function of the strain level and not of the load application history. In the elastoplastic condition, which follows the initial elastic condition, the stress-strain relationship is not proportional anymore. In the elasto-plastic condition, the material exhibits an elastic (recoverable) deformation and a plastic, unrecoverable, deformation (yielding zone). The limit between the two aforementioned conditions is called the *yield point* [10].

This paper presents the results of analyzing the mixture design of different HMAs in terms of both indirect tensile strength and energy parameters computed from the load-displacement curve (Figure 3). The first energy parameter corresponds to the toughness (energy I plus energy II, as subsequently defined, in Figure 3). The second energy parameter computed corresponds to the area under the force-displacement curve up to the maximum load value (or *failure*). This parameter is called *energy I*. The last energy parameter calculated (termed *energy II*) is the area under the force-displacement curve from the maximum load value to the displacement corresponding to zero load.

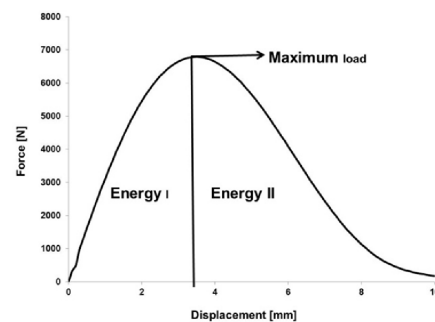

Figure 3. Force-displacement relation and energy parameters

The HMAs studied were fabricated using a B60-70 asphalt binder, a dense-graded aggregate, mineral filler, and different types and contents of mineral filler replacements (i.e., lime, Portland cement (or cement), and fly ash).

2. METHODOLOGY AND MATERIALS

Figure 4 summarizes the research methodology applied, which includes first the gradation selection and materials characterization (asphalt binder, aggregates, and mineral fillers). The application of the Marshall mixture design method led to determination of the optimum asphalt content for the HMA [12,13]. Based on this asphalt content, Marshall specimens were fabricated: (i) using 100% mineral filler (100% passing through a No. 200 sieve material); and (ii) replacing the mineral filler in different proportions (25, 50, 75, and 100%) by lime, cement, and fly ash. These HMA specimens were subjected to the ITT at 15 °C in accordance with UNE-EN-12697-23 [14] to determine the tensile strength. The assessment also included the analysis of the aforementioned energy parameters.

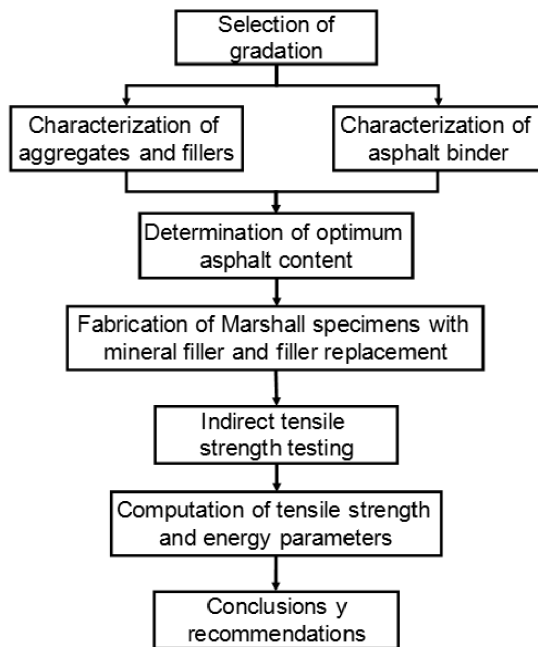

Figure 4. Research methodology

2.1 Gradation selection

The aggregate gradation used corresponds to that of a dense-graded mixture (md-10) specified by the Bogotá,

D.C. Institute of Urban Development (IDU) [15]. Figure 5 shows the corresponding master aggregate gradation band and the actual gradation used (the average gradation curve is defined based on the band limits). The md-10 mixture is typically used as surface course for pavement structures constructed in Bogotá, D.C.

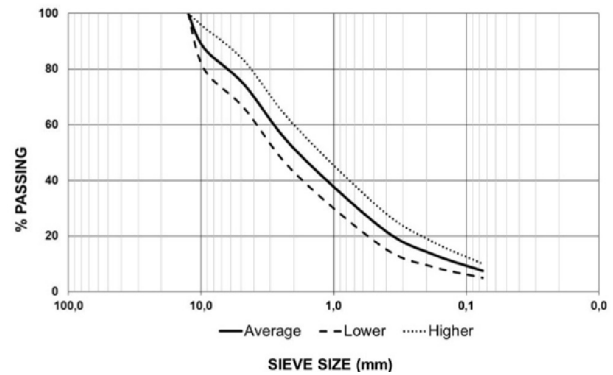

Figure 5. Md-10 gradation specification and gradation curve (average) of the assessed HMA

2.2 Aggregate, mineral filler, and asphalt binder characterization

Table 1 summarizes the characterization tests and corresponding parameter results conducted on the selected aggregate. According to these results, the aggregate used met the IDU specifications for HMA fabrication [15].

Table 1. Aggregate characteristics

Test	Standard	Result
Coarse aggregate absorption	ASTM C 127	3.36%
Coarse aggregate apparent specific gravity	ASTM C 127	2.38
Fine aggregate absorption	ASTM C 128	2.57%
Fine aggregate apparent specific gravity	ASTM C 128	2.46
Los Angeles abrasion	ASTM C 535	25.6%

The asphalt binder (B60-70) used was fabricated by the refinery of Barrancabermeja (Colombia). Table 2 summarizes the results of the characterization tests performed on this asphalt binder. This asphalt binder met the IDU specifications for HMA fabrication [15].

Table 2. Asphalt binder characteristics

Test	Standard	Result
Penetration	ASTM D 5-97	62 (1/10 mm)
Ductility	ASTM D 113-99	115 cm
Viscosity	ASTM D 2170-95	1500 poises
Softening point	ASTM D 36-95	43 °C
Flash and fire point	ASTM D 3143-98	220 °C and 225 °C

The specific gravity of the materials used as a mineral filler replacement corresponded to:

- lime 2.52 t/m³
- cement 2.83 t/m³
- fly ash 2.18 t/m³

3. ANALYSIS OF RESULTS

This section presents the results and corresponding analysis in terms of: (i) mixture design, (ii) tensile strength and displacement at failure, and (iii) energy parameters.

3.1 Mixture design

The optimum asphalt content determined based on the analysis of stability (Figure 6), density (Figure 7), and flow values (Figure 8) measured for the HMA Marshall specimens was 6 %. Thus, the ITT tests were conducted on Marshall specimens compacted at 75 blows per face, at 6 % asphalt binder content. The target total air voids content for all the compacted HMA specimens was 5 %.

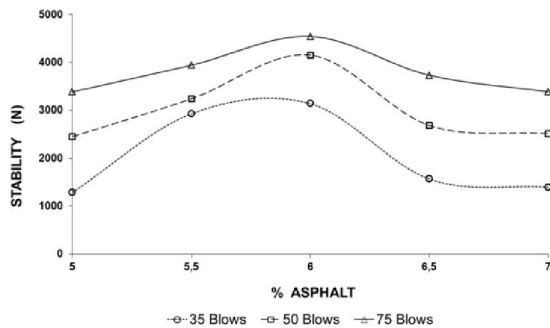

Figure 6. Results of Marshall stability tests

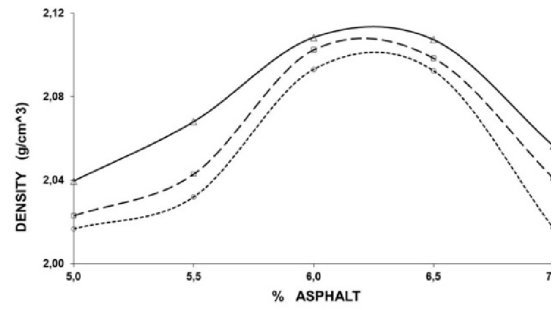

Figure 7. Results of density tests

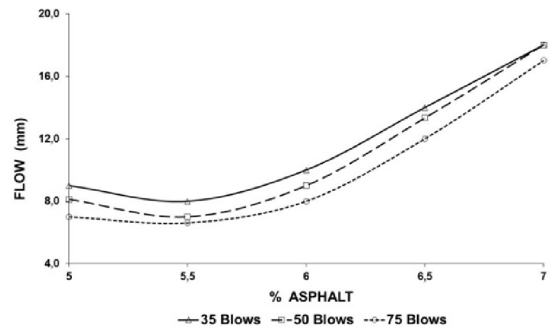

Figure 8. Results of Marshall flow values

3.2 Tensile strength and displacement at failure

Figures 9, 10, and 11 show the force-displacement curves obtained for the HMA specimens fabricated with the inclusion of both mineral filler and diverse mineral filler replacements. The percentages of replacement are indicated in each of these figures.

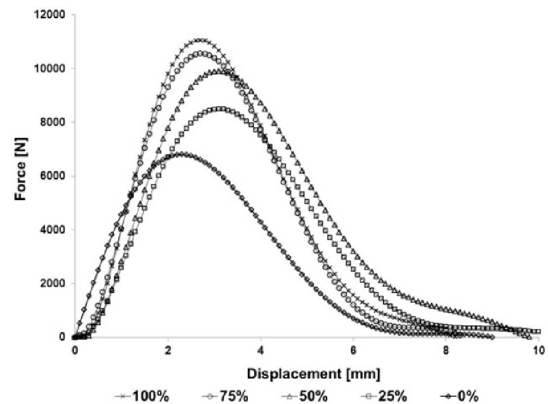

Figure 9. Force-displacement curve for specimens fabricated with and without lime replacement

Figure 9 shows that the specimens fabricated with mineral filler led to smaller displacement values at failure (i.e.,

at the tensile strength) as compared to the displacement values shown by specimens that include lime as a filler replacement. This response suggests that lime inclusion led to increase the HMA ductility, which benefits the mixture response under repeated traffic load. In addition, lime inclusion led to an increase in the tensile strength as compared to that of specimens fabricated with 100% mineral filler. Replacements of 25 and 50% were the most beneficial in terms of higher displacement values at failure, whereas 75 and 100% replacement offered the best response in terms of the tensile strength.

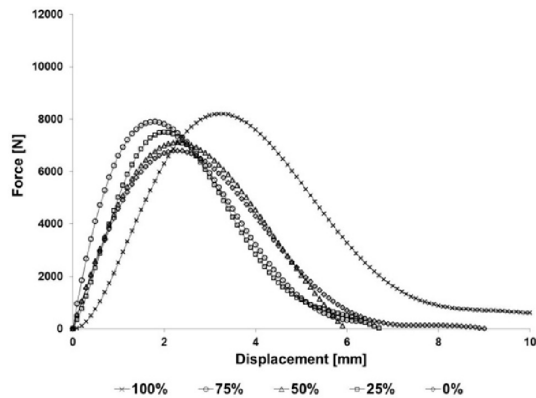

Figure 10. Force-displacement curve for specimens fabricated with and without fly ash replacement

Full replacement of mineral filler by fly ash generated higher displacement at failure and tensile strength values than those measured for specimens fabricated using 100% mineral filler (Figure 10). In addition, replacement of mineral filler by fly ash at proportions of 25, 50, and 75% led to higher tensile strength values and the displacement values at failure decreased showing a more rigid behavior.

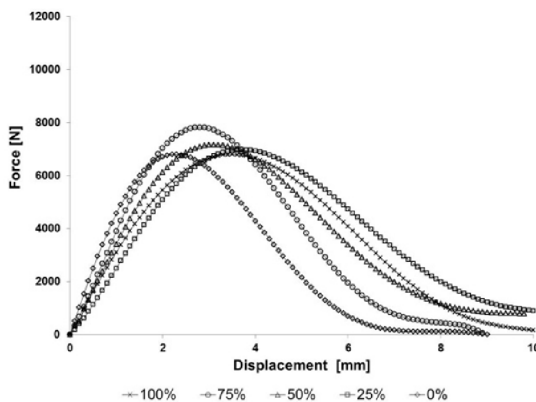

Figure 11. Force-displacement curve for specimens fabricated with and without cement replacement

Inclusion of cement produced in all cases (i.e., proportions) specimens with higher values of displacement at failure compared to specimens fabricated using 100% mineral filler (Figure 11). Although the changes in tensile strength are not significant, the positive effect of the addition of cement on the displacement at failure is remarkable.

Figure 12 shows the tensile strength (as force) values obtained for specimens fabricated using lime, cement, and fly ash as a replacement of the mineral filler. Figure 13 shows the change of tensile strength as compared to the tensile strength of mixtures fabricated using 100% mineral filler.

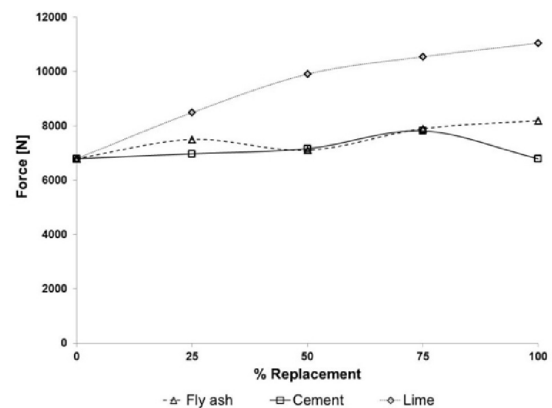

Figure 12. Tensile strength for specimens fabricated with and without lime, cement, and fly ash replacement

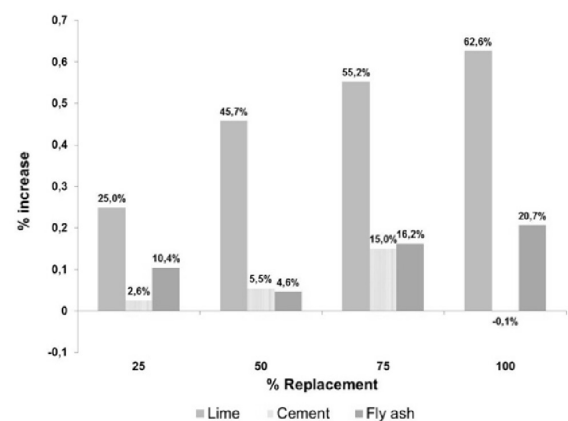

Figure 13. Change of tensile strength (%Increase) for specimens fabricated with lime, cement, and fly ash replacement

Figures 12 and 13 indicate that replacing the mineral filler by lime and fly ash generated higher tensile strength values, disregarding the proportion of replacement. In these cases, the tensile strength increased up to 63 and 21% for lime and fly ash, respectively. For the HMA specimens fabricated with cement replacement, the maximum strength increase was 15% (for 75% replacement of mineral filler) and there was no change in strength reported for 100% replacement of mineral filler.

3.3 Energy parameters

The third stage of analysis focused on computing the energy parameters: energy I, energy II, and toughness (based on the load-displacement curves reported). Figure 14 shows the toughness of HMA specimens fabricated with different types and proportions of filler replacement. Replacement at any proportion of mineral filler by lime and cement increased the toughness of HMA. The best responses were obtained for specimens fabricated with the replacement of mineral filler by 50% lime and with cement at 25%. Replacement of 25% of mineral filler by fly ash reduced the HMA toughness 10%, while additions of fly ash at 50 and 75% led to minimum changes in toughness. However, the toughness increased 43% for specimens fabricated by fully replacing the mineral filler with fly ash.

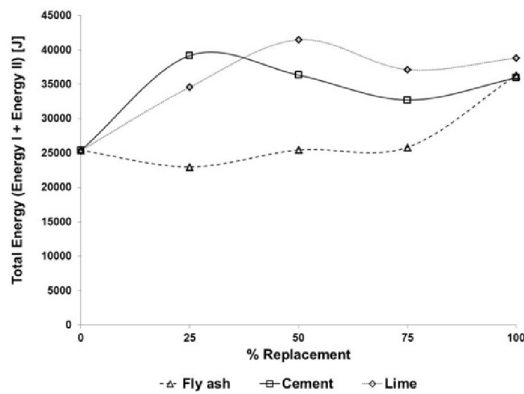

Figure 14. Toughness values of specimens fabricated with and without lime, cement, and fly ash replacement

Fly ash addition (in proportions of 25, 50, and 75%) produced reductions of the energy I values (Figure 15). On the contrary, mixtures that incorporated 100% fly ash showed an increment of 39% in the same energy

parameter. Replacement of mineral filler by cement and lime, in any proportion, resulted in higher energy I values. The increase was between 38 and 59% for lime replacement and 30 and 50% for cement replacement. Maximum increases of the energy I values were obtained for replacements of 50% lime, 25% cement, and 100% fly ash.

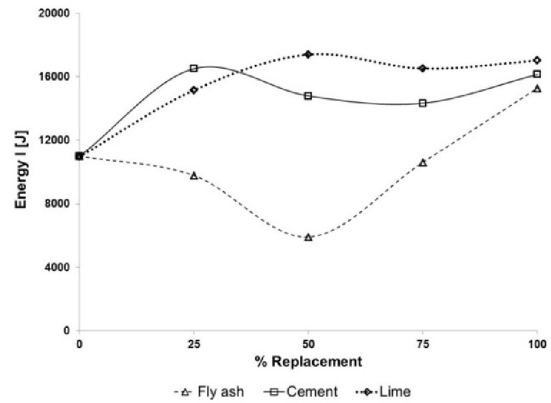

Figure 15. Energy I values for specimens fabricated with and without lime, cement, and fly ash replacement

Replacement of mineral filler by lime, cement, and fly ash increased the values of energy II, except for the replacement at 25% fly ash (Figure 16). The energy II parameter increased up to 67% for 50% lime replacement and 57% for 25% cement replacement. Replacement of mineral filler by 50 and 100% of fly ash produced, for this replacement type, the highest increases of the energy II parameter.

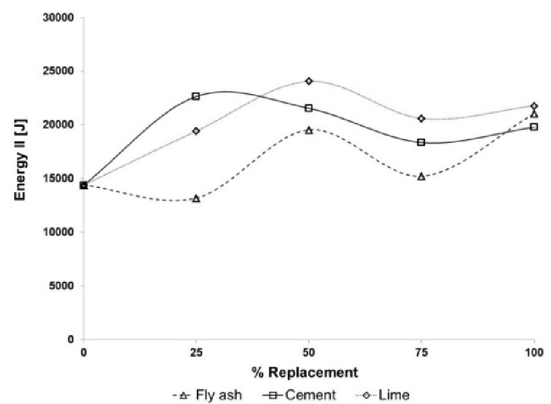

Figure 16. Energy II values for specimens fabricated with and without lime, cement, and fly ash replacement

The most commonly used criterion for the selection of fillers to be used in the fabrication of HMA corresponds

to the assessment of gradation. In addition, the criterion for selection of the optimum filler content is commonly based on the tensile strength (i.e., content that maximizes this strength). Table 3 summarizes the optimum values of filler content replacement, determined based on the maximum values of both tensile strength and energy parameters discussed.

Table 3. Optimum values of filler content replacement based on both the tensile strength and energy parameters

Type of filler replacement	TS (%)	To (%)	En I (%)	En II (%)
lime	100	50	50	50
cement	75	25	25	25
fly ash	100	100	100	100

TS= optimum based on tensile strength; To= optimum based on toughness;

En I= optimum based on energy I; En II= optimum based on energy II

Corresponding results indicate that the optimum filler content selected based on maximum tensile strength values is not necessarily coincident with that obtained based on energy parameters. In the case analyzed, for example, differences in optimum filler content are substantial for both lime and cement replacement cases.

For the particular combination of materials studied, both maximum tensile strength and energy parameters criteria led to conclude that the replacement of mineral filler by lime generates the best HMA response (as compared to both fly ash and cement replacement). However, different conclusions can be expected for other material combinations (i.e., asphalt binder and aggregate types) where the analysis of energy parameters can constitute an additional criterion for the proper selection of material combinations and mix design. The analysis conducted suggests that the inclusion of energy parameters can benefit the HMA mixture design process in terms of selection of the optimum type of filler and its proportion in the HMA.

4. CONCLUSIONS

This paper presents the analysis of a densegraded HMA in terms of energy parameters (determined based on the force-displacement curve obtained by the ITT) and tensile strength values. Results and analyses conducted in the study led to the following conclusions and recommendations:

- Replacement of mineral filler by cement, lime, and fly ash modified the HMA response in terms of tensile strength, displacement at failure, maximum deformation, and energy parameters obtained from the force-displacement curve (ITT).
- Quantification of energy parameters based on the force-displacement curve determined for the ITT can be successfully applied to define the best type of filler and its optimum proportion in the HMA design process. The optimum filler type and content depends on the material combinations (asphalt binder-aggregate) used in each particular HMA. As a result, the energy parameters can constitute additional criteria in order to better define the optimum asphalt content values of HMA and improve the overall mixture design process.
- Additional research is recommended to explore the routine implementation of the computation and analysis of the energy parameters presented for improving the mixture design of HMA.
- Additional research should also focus on the implementation of better tools to define optimum (e.g., minimum moisture damage susceptibility) material combinations (filler-asphalt binder-aggregate) as an initial screening tool for the HMA mixture design.

REFERENCES

- [1] BIANCHETTO, HUGO; MIRO, RODRIGO; MARTIENZ, ADRIANA; PEREZ, FELIX. Effect of filler on the ageing potential of asphalt mixture. Washington D.C. Transportation Research Board (TRB), 84th. 2005.
- [2] REYES, OSCAR; RINCON, FREDY. Influencia de las características del relleno mineral en la resistencia de una mezcla asfáltica. Medellín, Revista EIA, Escuela de Ingeniería de Antioquia. Vol 11, 93-103. 2009.
- [3] KENNEDY, THOMAS; HUDSON, WR. Application of the indirect tensile test to stabilized materials. Highway Research Record. Vol 35, 36-48, 1968.
- [4] YODER, JOSEPH; WITCZAK, MATTHEW. Principles of pavement design. USA. John Wiley & Sons, 2nd. 257-262. 1975.

- [5] ALFREDO, HERNANDEZ. Estudio de la cohesión y la tenacidad del betún y su posible efecto en el comportamiento a fatiga. Tesis doctoral. Universidad Politécnica de Cataluña. 2009.
- [6] ANAND, L. Single-cristal elasto-viscoplasticity. Application to texture evolution in polycrystalline metals at large strains. *Computer methods in applied mechanics and engineering*. Vol 193, 5359-5383. 2004.
- [7] KRISHNAN, J.; RAJAGOPAL, K. Review of the uses and modeling of bitumen from ancient to modern times. *Applied mechanics review*. Vol 56. 149-214. 2003
- [8] INJUN SONG. Damage analysis in asphalt concrete mixture based on parameter relationships. Texas. Doctor of Philosophy Dissertation, Texas A&M University. 2004.
- [9] TCHONKOVA, M.; Sture, S. Classical and recent formulations for linear elasticity. *Archives of computational methods in engineering*. Vol 8. 41-74. 2001.
- [10] PÄR JONSÉN. Fracture and stress in power compacts. Sweden. Doctoral thesis Lulea University of Technology. 2006.
- [11] OLLER, SERGIO. Fractura mecánica. Un enfoque global. Barcelona. Ediciones CIMNE y UPC. 2001.
- [12] INSTITUTO NACIONAL DE VIAS-INVIAS. Especificaciones técnicas. Bogotá D.C. Editorial Escuela Colombiana de Ingeniería. 1997.
- [13] ASPHALT INSTITUTE. Performance graded asphalt binder specification and testing. USA. Asphalt Institute. Serie I. 1996.
- [14] AENOR-NORMAS TECNICAS EUROPEAS. UNE-EN-12697-23. Determinación de la resistencia a la tracción indirecta de probetas bituminosas a 15°C. España. AENOR. 2007.
- [15] INSTITUTO DE DESARROLLO URBANO-IDU. Especificaciones técnicas generales de materiales y construcción para proyectos de infraestructura vial y de espacio público en Bogotá. Bogotá D.C. Instituto de Desarrollo Urbano. 2006.